



**FAG**

## BTAC52 [↗](#)

Sealing ring

Bolt-on seals BTAC, for SNS-housing,  
attached

### Technical information

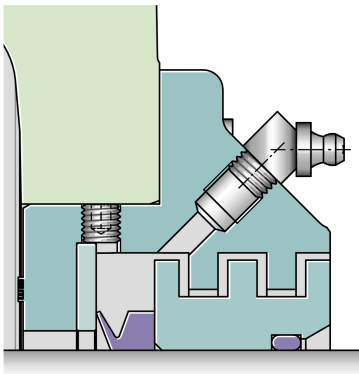

#### Main Dimensions & Performance Data

d	244 mm	Shaft diameter
b	71 mm	Width
g	41 mm	Overhang outside
d <sub>a</sub>	380 mm	Outside diameter
d <sub>c</sub>	356 mm	Centering Diameter
≈m	16,7 kg	Weight