



FAG

BTAC56 [↗](#)

Sealing ring

Bolt-on seals BTAC, for SNS-housing,
attached

Technical information

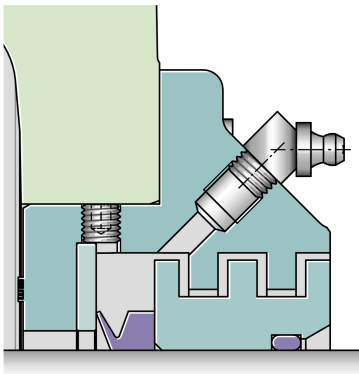

Main Dimensions & Performance Data

d	264 mm	Shaft diameter
b	71 mm	Width
g	41 mm	Overhang outside
d _a	410 mm	Outside diameter
d _c	380 mm	Centering Diameter
≈m	19,1 kg	Weight