

**RSHE30-XL-N**

Plummer block housing unit

Plummer block housing units RSHE, cast iron housing, radial insert ball bearing with eccentric locking collar, R seals

X-life

Technical information

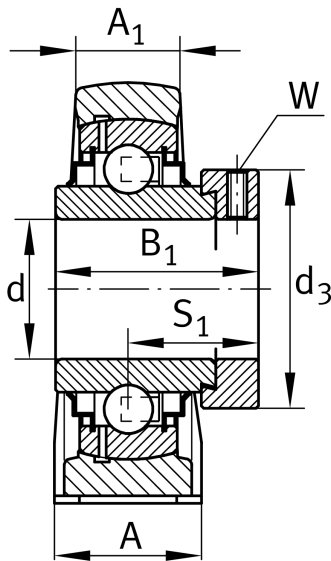

Your current product variant

Groove	N	Cast iron housing with undercut slot for end caps
Material	GG	Grey cast iron

Main Dimensions & Performance Data

d	30 mm	Bore diameter
L	98 mm	Length total
H ₂	82 mm	Height
≈m	1,01 kg	Weight

Mounting dimensions

J	76,2 mm	Distance fixing bore
K	M10	Thread fixing bore

Dimensions

H	42,9 mm	Distance shaft axis
A	40 mm	Width (base)
A ₁	25 mm	Width (head)
Q	M6	Connection thread for lubrication
B ₁	48,5 mm	Locking collar total width
S ₁	30,2 mm	Distance of raceway to locking collar



Additional information

SHE06	Housing
GE30-XL-KRR-B	Bearing designation
KASK06	Protecting cap

Temperature range

T _{min}	-20 °C	Operating temperature min.
T _{max}	120 °C	Operating temperature max.