

**TASE30-XL-N**

Plummer block housing unit

Plummer block housing units TASE, cast iron housing, radial insert ball bearing with eccentric locking collar, T seals

X-life

Technical information



Your current product variant

Material	GG	Grey cast iron
Groove	N	Cast iron housing with undercut slot for end caps
Material	GG	Cast iron

Main Dimensions & Performance Data

d	30 mm	Bore diameter
L	158 mm	Length total
H ₂	82 mm	Height
≈m	1,2 kg	Weight

Mounting dimensions

J	117,5 mm	Distance fixing bore
N	14 mm	Width (slot)
N ₁	22 mm	Length (slot)

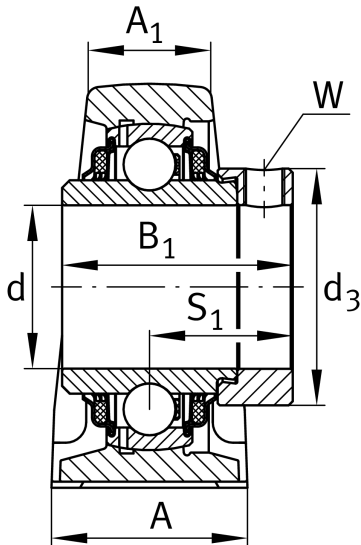



Dimensions

H	42,9 mm	Distance shaft axis
A	40 mm	Width (base)
A ₁	25 mm	Width (head)
H ₁	17 mm	Height (base)
B ₁	48,5 mm	Locking collar total width
S ₁	30,2 mm	Distance of raceway to locking collar
Q	M6	Connection thread for lubrication

Additional information

ASE06	Housing
GE30-XL-KTT-B	Bearing designation
KASK06	Protecting cap

Temperature range

T _{min}	-20 °C	Operating temperature min.
T _{max}	120 °C	Operating temperature max.