



FAG

BND2218-Z-Y-AL-D

Housing body

for bearings with cylindrical bore, BND

Technical information

Main Dimensions & Performance Data



d 1	90 mm	Shaft diameter
a	370 mm	Length base
h 1	220 mm	Total height
g 1	104 mm	Total width with lid g1
g 5	106 mm	Total width with lid g5
≈m	18 kg	Weight

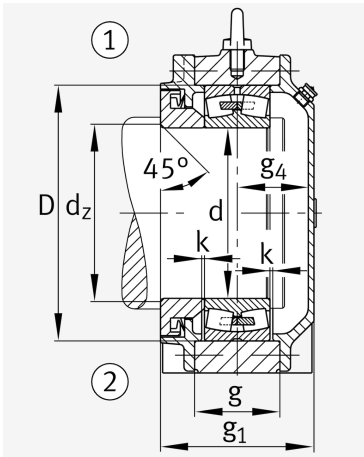
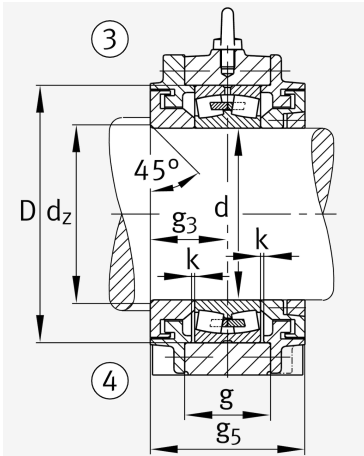
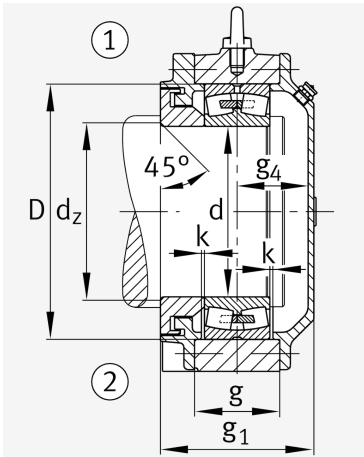
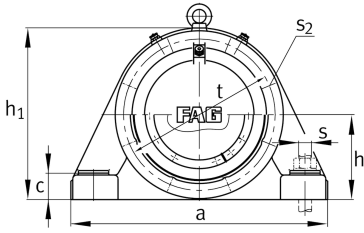

Dimensions

	45 °	Chamfer angle
b	110 mm	Width base
c	38 mm	Height base foot
D	160 mm	Outside Diameter
d _c	98 mm	Chamfer diameter c
g	55 mm	Width housing body
g ₃	53 mm	Locking collar width g3
g ₄	45 mm	Locking collar width g4
h	110 mm	Distance shaft axis
k	2 mm	Axial displacement
m	290 mm	Distance fixing bore
n	60 mm	Bore distance width
s	M20	Size of fixing screws
s ₂	M8	Thread fixing bore
s ₂	6	Number of screwing holes
t	185 mm	Pitch circle dia fixing holes
u	23 mm	Width oblong holes
v	32 mm	Lenght oblong hole

Additional information

	22218	Bearing designation
--	-------	---------------------

Temperature range

T _{min}	-20 °C	Operating temperature min.
T _{max}	100 °C	Operating temperature max.



View product details on medias

08.05.2026, 15:59:10 UTC

SCHAEFFLER

