

**LASE40-XL-N**

## Plummer block housing unit

Plummer block housing units LASE, cast iron housing, radial insert ball bearing with eccentric locking collar, L seals

X-life

## Technical information

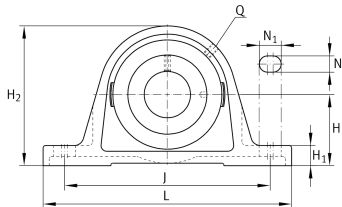

## Your current product variant

Material	GG	Grey cast iron
Groove	N	Cast iron housing with undercut slot for end caps

## Main Dimensions &amp; Performance Data

d	40 mm	Bore diameter
L	179 mm	Length total
H <sub>2</sub>	99 mm	Height
≈m	1,97 kg	Weight

## Mounting dimensions

J	138,25 mm	Distance fixing bore
N	14 mm	Width (slot)
N <sub>1</sub>	26 mm	Length (slot)

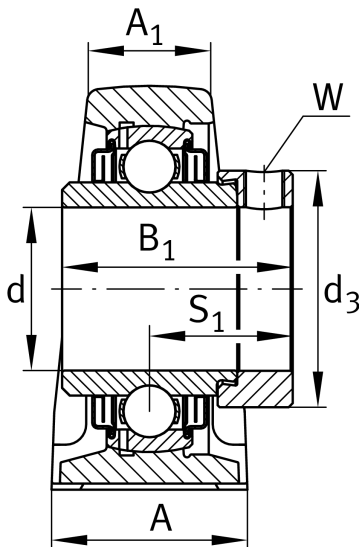



### Dimensions

H	49,2 mm	Distance shaft axis
A	48 mm	Width (base)
A <sub>1</sub>	30 mm	Width (head)
H <sub>1</sub>	19 mm	Height (base)
B <sub>1</sub>	56,5 mm	Locking collar total width
S <sub>1</sub>	35,1 mm	Distance of raceway to locking collar
Q	M6	Connection thread for lubrication

### Additional information

GEHASE08-GG-N-FA125.1	Housing
GE40-XL-KLL-B	Bearing designation
KASK08	Protecting cap

### Temperature range

T <sub>min</sub>	-40 °C	Operating temperature min.
T <sub>max</sub>	180 °C	Operating temperature max.