

**TSHE35-XL-N**

Plummer block housing unit

Plummer block housing units TSHE, cast iron housing, radial insert ball bearing with eccentric locking collar, T seals

X-life

Technical information

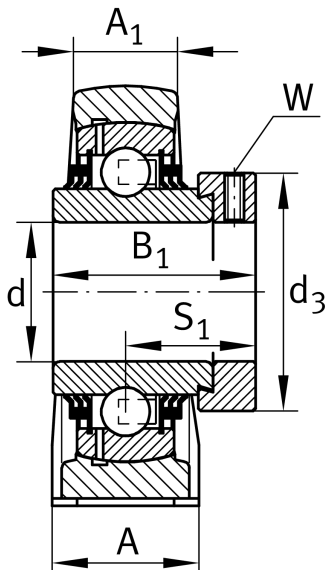

Your current product variant

Groove	N	Cast iron housing with undercut slot for end caps
Material	GG	Grey cast iron

Main Dimensions & Performance Data

d	35 mm	Bore diameter
L	103 mm	Length total
H ₂	93 mm	Height
≈m	1,36 kg	Weight

Mounting dimensions

J	82,6 mm	Distance fixing bore
K	M10	Thread fixing bore

Dimensions

H	47,6 mm	Distance shaft axis
A	45 mm	Width (base)
A ₁	27 mm	Width (head)
Q	M6	Connection thread for lubrication
S ₁	32,5 mm	Distance of raceway to locking collar



Additional information

SHE07	Housing
GE35-XL-KTT-B	Bearing designation
KASK07	Protecting cap

Temperature range

T _{min}	-20 °C	Operating temperature min.
T _{max}	120 °C	Operating temperature max.