

**RASE35-XL-FA164** [↗](#)

Plummer block housing unit

Plummer block housing unit RASE..-XL-FA164, RIBB cast iron ASE SAO AK

X-life

Technical information



Your current product variant

Material	GG	Grey cast iron
Manufacturing instruction	FA164	High temperature design up to +250°C

Main Dimensions & Performance Data

d	35 mm	Bore diameter
L	163 mm	Length total
H ₂	93 mm	Height
≈m	1,6 kg	Weight

Mounting dimensions

J	126 mm	Distance fixing bore
N	14 mm	Width (slot)
N ₁	21 mm	Length (slot)

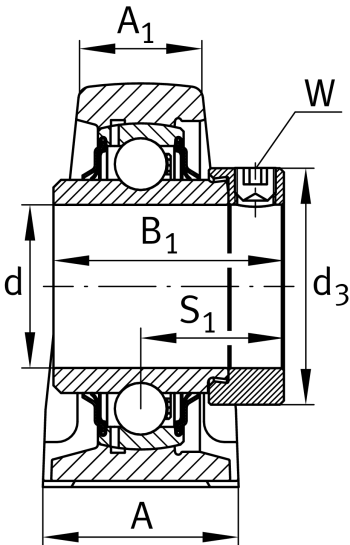



Dimensions

H	47,6 mm	Distance shaft axis
A	45 mm	Width (base)
A ₁	27 mm	Width (head)
H ₁	19 mm	Height (base)
B ₁	51,3 mm	Locking collar total width
S ₁	32,5 mm	Distance of raceway to locking collar
Q	M6	Connection thread for lubrication

Additional information

ASE07-FA125	Housing
GE35-XL-KRR-B-FA164	Bearing designation
KASK07-J	Protecting cap

Temperature range

T _{min}	150 °C	Operating temperature min.
T _{max}	250 °C	Operating temperature max.