

**GE480-DO-2RS4**

Spherical plain bearing

Radial spherical plain bearing, requiring maintenance, sliding contact surface: steel/steel; DIN ISO 12240-1, dimension series C, sealed

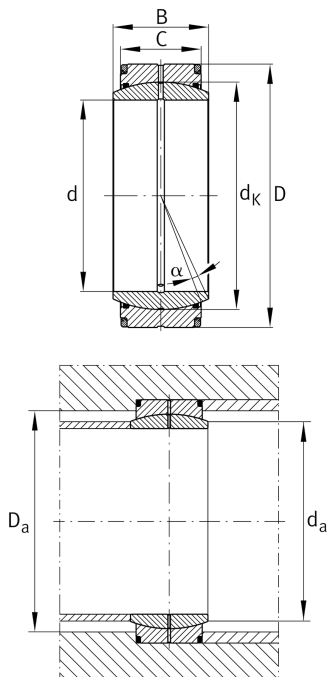

Technical information

**Your current product variant**

Maintenance	Maintenance required	
Material	Steel	
Sealing	2RS4	Lip seals with increased sealing action on both sides
Radial internal clearance	CN (Group N)	Normal internal clearance
Coating	Durotect M	Inner- and outer ring coated with Durotect M (Manganese Phosphate)

Main Dimensions & Performance Data

d	480 mm	Bore diameter bearing
D	650 mm	Outside diameter bearing
B	230 mm	Width inner ring
C _r	12.000.000 N	Basic dynamic load rating, radial
C _{0r}	46.000.000 N	Basic static load rating, radial
m	232,6 kg	Weight

Mounting dimensions

r _{1min}	2 mm	Edge Spacing
r _{2min}	5 mm	Edge Spacing
d _{a max}	516 mm	Connection measure Inner ring
D _{a min}	536 mm	Housing Connection Diameter



Dimensions









C	195 mm	Width Outer ring
d_K	565 mm	Ball diameter
α	3,8 °	Tilt angle
d_{OT}	0 mm	Bore diameter bearing, upper tolerance
d_{UT}	-0,045 mm	Bore diameter bearing, lower tolerance
D_{OT}	0 mm	Outside diameter, upper tolerance
D_{UT}	-0,075 mm	Outside diameter, lower tolerance
B_{OT}	0 mm	Width inner ring, upper tolerance
B_{UT}	-0,45 mm	Width inner ring, lower tolerance
C_{OT}	0 mm	Width outer ring, upper tolerance
C_{UT}	-1,1 mm	Width outer ring, lower tolerance
G_r	0,145 - 0,285	Radial Clearance
G_{rmax}	0,285 mm	Radial clearance, maximum
G_{rmin}	0,145 mm	Radial clearance, minimum

Temperature range

T_{min}	-30 °C	Operating temperature min.
T_{max}	130 °C	Operating temperature max.



Characteristics

-  Radial load
-  Axial load in one direction
-  Axial load in two directions
-  Grease Lubrication
-  Sealed on both sides
-  Large bearing
-  Static angular error and misalignment
-  Dynamic angular error and misalignment