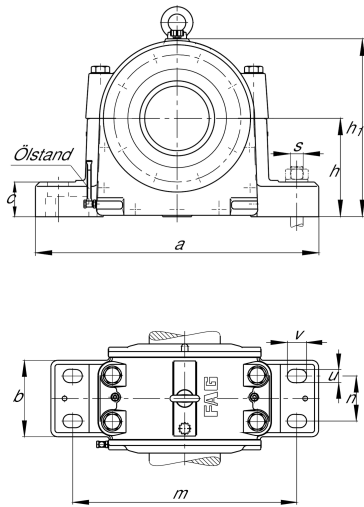

**FAG****LOE218-N-BF-L**

Plummer block housing

Plummer block housing, split, for spherical roller bearings, oil-lubrication

Technical information

**Main Dimensions & Performance Data**

d	90 mm	Shaft diameter
a	410 mm	Length base
h ₁	245 mm	Height
g ₁	225 mm	Total width
≈m	45 kg	Weight

Dimensions

b	150 mm	Width base
c	48 mm	Height base
D	160 mm	Outside diameter bearing
d ₂	95 mm	Shaft diameter shoulder
d ₅	M90X2	Thread shaft nut
g	160 mm	Width housing body
h	135 mm	Center height
m	340 mm	Distance fixing bore
n	80 mm	Bore distance width
s	M20	Size of fixing screws
u	25 mm	Width slot
v	35 mm	Length slot
w	61 mm	Location collar width



Additional information

1,5 l	Oil quantity first filling
60 mm	Maximum height oil level
45 mm	Minimum height oil level

Temperature range

T _{min}	-20 °C	Operating temperature min.
T _{max}	100 °C	Operating temperature max.