

**TSHE40-XL-N**

Plummer block housing unit

Plummer block housing units TSHE, cast iron housing, radial insert ball bearing with eccentric locking collar, T seals

X-life

Technical information

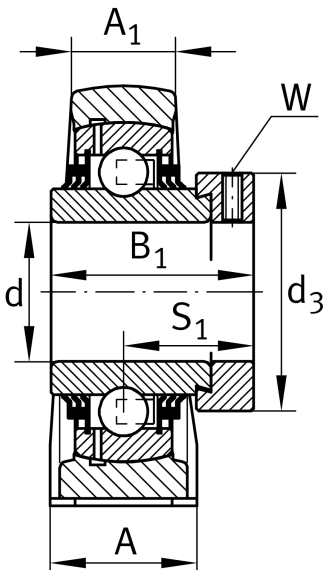

Your current product variant

Groove	N	Cast iron housing with undercut slot for end caps
Material	GG	Grey cast iron

Main Dimensions & Performance Data

d	40 mm	Bore diameter
L	116 mm	Length total
H ₂	99 mm	Height
≈m	1,659 kg	Weight

Mounting dimensions

J	88,9 mm	Distance fixing bore
K	M12	Thread fixing bore

Dimensions

H	49,2 mm	Distance shaft axis
A	48 mm	Width (base)
A ₁	30 mm	Width (head)
Q	M6	Connection thread for lubrication
S ₁	35,1 mm	Distance of raceway to locking collar



Additional information

SHE08	Housing
GE40-XL-KTT-B	Bearing designation
KASK08	Protecting cap

Temperature range

T _{min}	-20 °C	Operating temperature min.
T _{max}	120 °C	Operating temperature max.