

**RTUEY50-XL**

Take-up housing unit

Take-up housing units RTUEY, cast iron housing, radial insert ball bearing with grub screws in inner ring, R seals

X-life

Technical information

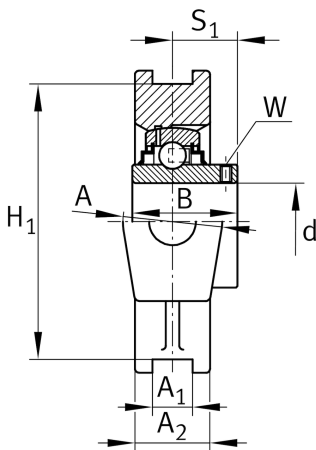

Your current product variant

| | | |
|----------|----|----------------|
| Material | GG | Grey cast iron |
|----------|----|----------------|

Main Dimensions & Performance Data

| | | |
|----|--------|---------------|
| d | 50 mm | Bore diameter |
| H | 115 mm | Height |
| L | 148 mm | Length total |
| ≈m | 2,4 kg | Weight |

Mounting dimensions

| | | |
|----------------|----------|--|
| A ₁ | 16 mm | Width guidance groove |
| | H13 | Width guidance groove clearance |
| H ₁ | 102 mm | Distance guidance grooves |
| | 0,15 mm | Upper distance guidance groove tolerance |
| | -0,15 mm | Lower distance guidance groove tolerance |
| N | 29 mm | Fixing bore |



Dimensions

| | | |
|----------------|---------|---------------------------------------|
| L ₁ | 90 mm | Distance shaft axis |
| L ₂ | 16 mm | Length fixed link |
| L ₃ | 85 mm | Length guidance groove |
| A | 50 mm | Width housing fixing side |
| N ₁ | 20 mm | Width recess |
| N ₂ | 49 mm | Height recess |
| B | 51,6 mm | Width inner ring |
| S ₁ | 32,6 mm | Distance of raceway to locking collar |
| T | 83 mm | Height housing fixing side |
| Q | M6 | Connection thread for lubrication |
| A ₂ | 35 mm | Width housing |

Additional information

| | |
|----------------|---------------------|
| TUE10 | Housing |
| GYE50-XL-KRR-B | Bearing designation |

Temperature range

| | | |
|------------------|--------|----------------------------|
| T _{min} | -20 °C | Operating temperature min. |
| T _{max} | 120 °C | Operating temperature max. |