

**RASE60-XL-N**

Plummer block housing unit

Plummer block housing units RASE, cast iron housing, radial insert ball bearing with eccentric locking collar, R seals

X-life

Technical information



Your current product variant

Material	GG	Grey cast iron
Groove	N	Cast iron housing with undercut slot for end caps

Main Dimensions & Performance Data

d	60 mm	Bore diameter
L	240 mm	Length total
H ₂	140 mm	Height
≈m	4,75 kg	Weight

Mounting dimensions

J	190 mm	Distance fixing bore
N	18 mm	Width (slot)
N ₁	28 mm	Length (slot)

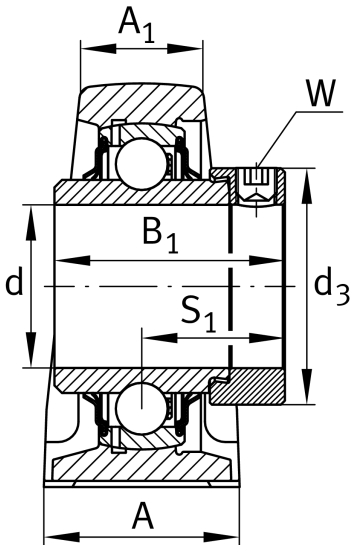



Dimensions

H	69,9 mm	Distance shaft axis
A	60 mm	Width (base)
A ₁	42 mm	Width (head)
H ₁	25 mm	Height (base)
B ₁	77,9 mm	Locking collar total width
S ₁	46,9 mm	Distance of raceway to locking collar
Q	M6	Connection thread for lubrication

Additional information

ASE12	Housing
GE60-XL-KRR-B	Bearing designation
KASK12	Protecting cap

Temperature range

T _{min}	-20 °C	Operating temperature min.
T _{max}	120 °C	Operating temperature max.