

**GE10-DO-E**

Spherical plain bearing

Standard performance Radial spherical plain bearing, requiring maintenance, sliding contact surface: steel/steel, DIN ISO 12240-1, dimension series E, open design

Technical information

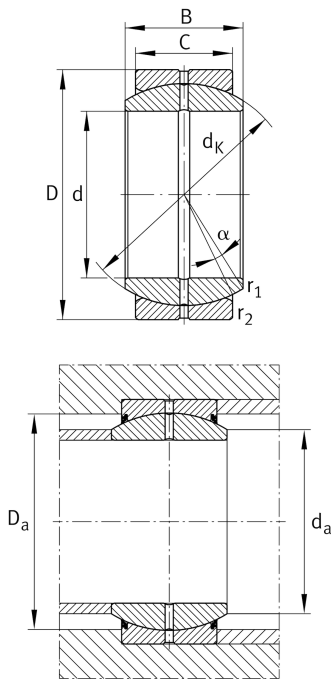

Your current product variant

Maintenance	Maintenance required
Material	Steel
Type of Seal	Without
Radial internal clearance	CN (Group N) Normal internal clearance
Coating	Durotect M Inner- and outer ring coated with Durotect M (Manganese Phosphate)

Main Dimensions & Performance Data

d	10 mm	Bore diameter bearing
D	19 mm	Outside diameter bearing
B	9 mm	Width inner ring
C _r	8.160 N	Basic dynamic load rating, radial
C _{0r}	40.800 N	Basic static load rating, radial
≈m	0,011 kg	Weight

Mounting dimensions

r _{1smin}	0,3 mm	Edge Spacing
r _{2smin}	0,3 mm	Edge Spacing
d _{a max}	13,2 mm	Connection measure Inner ring
D _{a min}	15,3 mm	Housing Connection Diameter



Dimensions

C	6 mm	Width Outer ring
d _K	16 mm	Ball diameter
α	12 °	Tilt angle
d _{OT}	0 mm	Bore diameter bearing, upper tolerance
d _{UT}	-0,008 mm	Bore diameter bearing, lower tolerance
D _{OT}	0 mm	Outside diameter, upper tolerance
D _{UT}	-0,009 mm	Outside diameter, lower tolerance
B _{OT}	0 mm	Width inner ring, upper tolerance
B _{UT}	-0,12 mm	Width inner ring, lower tolerance
C _{OT}	0 mm	Width outer ring, upper tolerance
C _{UT}	-0,24 mm	Width outer ring, lower tolerance
G _r	0,032 - 0,068	Radial Clearance
G _{rmax}	0,068 mm	Radial clearance, maximum
G _{rmin}	0,032 mm	Radial clearance, minimum

Temperature range

T _{min}	-60 °C	Operating temperature min.
T _{max}	200 °C	Operating temperature max.

Characteristics

	Radial load
	Axial load in one direction
	Axial load in two directions
	Grease Lubrication
	Sealed on both sides
	Static angular error and misalignment
	Dynamic angular error and misalignment