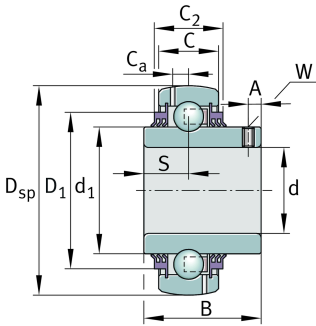

**GY1112-XL-KTT-B-AS2/V**

Radial insert ball bearing

X-life

Technical information

**Your current product variant**

Lubrication hole transposed AS2/V

Main Dimensions & Performance Data

d	44,45 mm	Bore diameter
d	44,45 mm	Bore diameter, inch
D _{SP}	85 mm	Outside diameter
B	49,2 mm	Width
C _{0r}	20.400 N	Basic static load rating, radial
C _r	34.500 N	Basic dynamic load rating, radial
≈m	0,68 kg	Weight

Dimensions







C	22 mm	Width, outer ring
C ₂	25,51 mm	Sealing total width
S	19 mm	Distance raceway
d ₁	57,9 mm	Rib diameter inner ring
D ₁	71,72 mm	Outside diameter seal
C _a	6,4 mm	Distance to lubrication hole
A	7,94 mm	Distance thread
W	4,064 mm	Width of flats (inch)



Temperature range

T_{\min}	-20 °C	Operating temperature min.
T_{\max}	120 °C	Operating temperature max.

Characteristics

-  Radial load
-  Axial load in one direction
-  Axial load in two directions
-  Lifetime lubrication, freedom from maintenance
-  Grease Lubrication
-  Sealed on both sides
-  Static angular error and misalignment