



FAG

32240-XL>A

Tapered roller bearing

Tapered roller bearings 322, main dimensions acc. to DIN 720, separable

X-life

Technical information

Your current product variant

Tolerance class	PN	Normal (ISO 492:2014)
Heat treatment	Standard	
Cage	Standard	Sheet steel cage, window cage, roller-guided
Internal design	Standard	
Quality level	XL	X-life
Version code	>A	Not marked on bearing
Number of rows	1	Single-row design

Main Dimensions & Performance Data

d	200 mm	Bore diameter
D	360 mm	Outside diameter
B	98 mm	Width, inner ring
C	82 mm	Width, outer ring
T	104 mm	Width, total
C_r	1.570.000 N	Basic dynamic load rating, radial
C_{0r}	2.080.000 N	Basic static load rating, radial
C_{ur}	260.000 N	Fatigue load limit, radial
n_G	2.230 1/min	Limiting speed
n_{gr}	1.080 1/min	Thermal speed rating
$\approx m$	42,8 kg	Weight

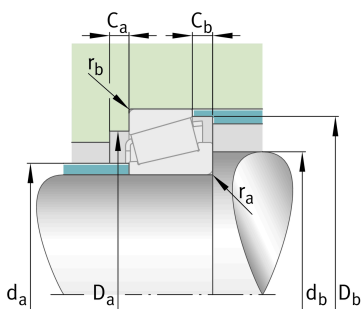



Mounting dimensions

$d_{a \max}$	226 mm	Maximum diameter of shaft shoulder
$d_{b \min}$	217 mm	Minimum diameter of shaft shoulder
$D_{a \min}$	302 mm	Minimum diameter of housing shoulder
$D_{a \max}$	342 mm	Maximum diameter of housing shoulder
$D_{b \min}$	340 mm	Minimum diameter of housing shoulder
$C_{a \min}$	11 mm	Minimum axial space
$C_{b \min}$	22 mm	Minimum axial space
$r_{a \max}$	5 mm	Maximum fillet radius of shaft
$r_{b \max}$	4 mm	Maximum fillet radius of housing

Dimensions

$r_{1, 2 \min}$	5 mm	Minimum chamfer dimension of inner ring back face
$r_{3, 4 \min}$	4 mm	Minimum chamfer dimension of outer ring back face
a	83 mm	Distance between the apexes of the pressure cones
d_1	269,5 mm	Guidance rib diameter of inner ring

Temperature range

T_{\min}	-30 °C	Operating temperature min.
T_{\max}	200 °C	Operating temperature max.

Calculation factors

e	0,41	Limiting value of F_a/F_r for the applicability of diff. Values of factors X and Y
Y	1,48	Dynamic axial load factor
Y_0	0,81	Static axial load factor







Additional information

T3GD200

Comparative designation to ISO 10317 and ISO 355



Characteristics

-  Radial load
-  Axial load in one direction
-  Grease Lubrication
-  Oil Lubrication
-  Not sealed
-  Large bearing