

**GE107-ZO-2RS-E**

Spherical plain bearing

Radial spherical plain bearing, requiring maintenance, sliding contact surface: steel/steel, inch size, sealed design

Technical information

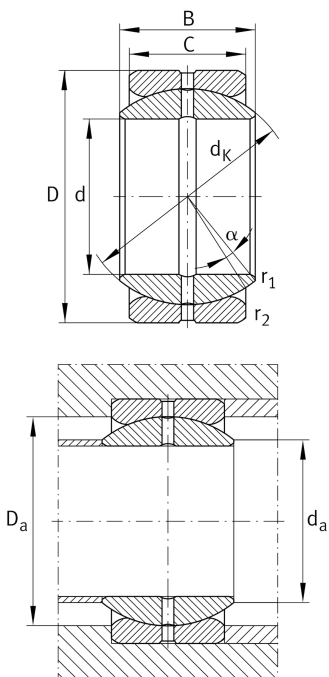

Your current product variant

Maintenance	Maintenance required	
Material	Steel	
Sealing	2RS	Lip seals on both sides
Radial internal clearance	CN (Group N)	Normal internal clearance
Coating	Durotect M	Inner- and outer ring coated with Durotect M (Manganese Phosphate)

Main Dimensions & Performance Data

d	107,95 mm	Bore diameter bearing
D	168,275 mm	Outside diameter bearing
B	94,463 mm	Width inner ring
C _r	1.000.000 N	Basic dynamic load rating, radial
C _{0r}	5.020.000 N	Basic static load rating, radial
≈m	8,4 kg	Weight

Mounting dimensions

r _{1smin}	1 mm	Edge Spacing
r _{2smin}	1 mm	Edge Spacing
d _{a max}	122,8 mm	Connection measure Inner ring
D _{a min}	138 mm	Housing Connection Diameter



Dimensions

C	80,95 mm	Width Outer ring
d _K	155 mm	Ball diameter
α	6 °	Tilt angle
d _{OT}	0 mm	Bore diameter bearing, upper tolerance
d _{UT}	-0,02 mm	Bore diameter bearing, lower tolerance
d _T	0,02	Bore diameter bearing, tolerance
D _{OT}	0 mm	Outside diameter, upper tolerance
D _{UT}	-0,025 mm	Outside diameter, lower tolerance
B _{OT}	0 mm	Width inner ring, upper tolerance
B _{UT}	0 mm	Width inner ring, lower tolerance
C _{OT}	0 mm	Width outer ring, upper tolerance
C _{UT}	-0,05 mm	Width outer ring, lower tolerance
G _r	0,13-0,23	Radial Clearance
G _{rmax}	0,23 mm	Radial clearance, maximum
G _{rmin}	0,13 mm	Radial clearance, minimum

Temperature range

T _{min}	-30 °C	Operating temperature min.
T _{max}	130 °C	Operating temperature max.



Characteristics



Radial load



Axial load in one direction



Axial load in two directions



Grease Lubrication



Sealed on both sides



Static angular error and misalignment



Dynamic angular error and misalignment