

**GE25-FO-2RS-E**

## Spherical plain bearing

Standard performance Radial spherical plain bearing, requiring maintenance, sliding contact surface: steel/steel, DIN ISO 12240-1, dimension series G, sealed

## Technical information

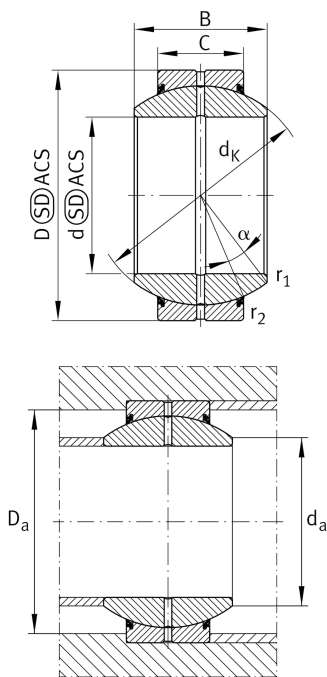

## Your current product variant

Maintenance	Maintenance required	
Material	Steel	
Type of Seal	2RS	Lip seals on both sides
Radial internal clearance	CN (Group N)	Normal internal clearance
Coating	Durotect M	Inner- and outer ring coated with Durotect M (Manganese Phosphate)

## Main Dimensions &amp; Performance Data

d	25 mm	Bore diameter bearing
D	47 mm	Outside diameter bearing
B	28 mm	Width inner ring
C <sub>r</sub>	62.300 N	Basic dynamic load rating, radial
C <sub>0r</sub>	311.000 N	Basic static load rating, radial
≈m	0,19 kg	Weight

## Mounting dimensions

r <sub>1smin</sub>	0,6 mm	Edge Spacing
r <sub>2smin</sub>	0,6 mm	Edge Spacing
d <sub>a max</sub>	29,5 mm	Connection measure Inner ring
D <sub>a min</sub>	38 mm	Housing Connection Diameter



## Dimensions

C	18 mm	Width Outer ring
$d_K$	40,7 mm	Ball diameter
$\alpha$	17 °	Tilt angle
$d_{OT}$	0 mm	Bore diameter bearing, upper tolerance
$d_{UT}$	-0,01 mm	Bore diameter bearing, lower tolerance
$D_{OT}$	0 mm	Outside diameter, upper tolerance
$D_{UT}$	-0,011 mm	Outside diameter, lower tolerance
$B_{OT}$	0 mm	Width inner ring, upper tolerance
$B_{UT}$	-0,12 mm	Width inner ring, lower tolerance
$C_{OT}$	0 mm	Width outer ring, upper tolerance
$C_{UT}$	-0,24 mm	Width outer ring, lower tolerance
$G_r$	0,05 - 0,1	Radial Clearance
$G_{rmax}$	0,1 mm	Radial clearance, maximum
$G_{rmin}$	0,05 mm	Radial clearance, minimum

## Temperature range

$T_{min}$	-30 °C	Operating temperature min.
$T_{max}$	130 °C	Operating temperature max.

## Characteristics

-  Radial load
-  Axial load in one direction
-  Axial load in two directions
-  Grease Lubrication
-  Sealed on both sides
-  Static angular error and misalignment
-  Dynamic angular error and misalignment