



TRI-SECTION-SET-8T [↗](#)

Tri-Section Puller

BETEX Hydraulic puller including tri-section plate for safe, easy dismantling of rolling bearings and other rotative components

Technical information

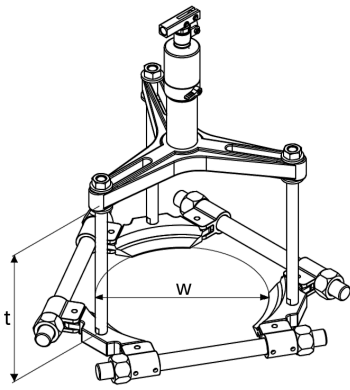

Technical data

w_{\min}	50 mm	Grip, width, min.
w_{\max}	270 mm	Grip width, max.
t_{\max}	243 mm	Grip depth, max.
F_p	75 kN	Pulling force
$\approx m$	34 kg	Weight

Additional information

Integrated pump-cylinder unit,
360° adjustable handle,
tri-section plate,
crossbar,
connection rods,
steel storage case

Scope of delivery