

**GIHNRK20-LO**

Rod end



Hydraulic rod end, with thread clamping device, right hand thread, requiring maintenance, sliding contact surface: steel/steel, DIN 24338 ISO 6982, open design

Technical information

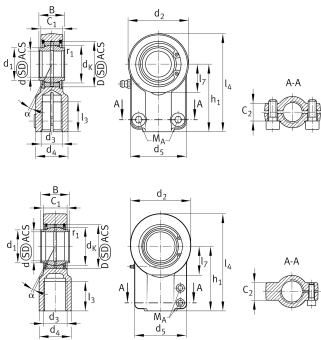
**Your current product variant**

Clampable	Clampable
Maintenance	Maintenance required
Mounting	Internal thread clampable
Lubrication nipple	DIN71412-AM6 (tapered grease nipple)
Slotted	Slotted, both sides
Thread Pitch	Right-hand thread
Type of Seal	Without
Radial internal clearance	CN (Group N) Normal internal clearance

Main Dimensions & Performance Data

C_r	38.500 N	Basic dynamic load rating, radial
C_{0r}	48.300 N	Basic static load rating, radial
d	20 mm	Bore diameter bearing
d_2	47 mm	Outer eye diameter
l_4	77 mm	Total length internal thread head
D	35 mm	Outside diameter bearing
B	20 mm	Width inner ring
$\approx m$	362,29 g	Weight



Dimensions

α	4 °	Tilt angle
C ₁	17 mm	Width of the rod end
C ₂	19 mm	Width
d _K	29 mm	Ball diameter
d ₃	M16x1,5	Thread size
d ₄	25 mm	Shank diameter
d ₅	47 mm	Shank diameter, large
d ₇	M8x20	Diameter screw clamp
h ₁	52 mm	Shank Length Internal thread head
l ₃	23 mm	Thread length Internal thread
l ₇	22 mm	Distance drilling with/shaft start
d _{UT}	0 mm	Bore diameter bearing, lower tolerance
d _T	H7	Bore diameter bearing, tolerance
d _{OT}	0,021 mm	Bore diameter bearing, upper tolerance
B _{UT}	-0,21 mm	Width inner ring, lower tolerance
B _{OT}	0 mm	Width inner ring, upper tolerance
M _A	32 Nm	Tightening torque
F _Z	20.000 N	Cylinder Force
G _r	CN	Radial Clearance
G _{rmin}	0,02 mm	Radial clearance, minimum
G _{rmax}	0,082 mm	Radial clearance, maximum

Mounting dimensions







r _{1smin}	0,3 mm	Edge Spacing
d ₁	25 mm	Outer flange diameter inner ring



Temperature range

T_{\min}	-60 °C	Operating temperature min.
T_{\max}	200 °C	Operating temperature max.

Characteristics

-  Radial load
-  Axial load in one direction
-  Axial load in two directions
-  Grease Lubrication
-  Not sealed
-  Static angular error and misalignment
-  Dynamic angular error and misalignment