

**GE560-DF-G9**

## Spherical plain bearing

Radial spherical plain bearing, maintenance-free, sliding contact surface: GFK / hard chromium, DIN ISO 12240-1, dimension series C, open design

## Technical information

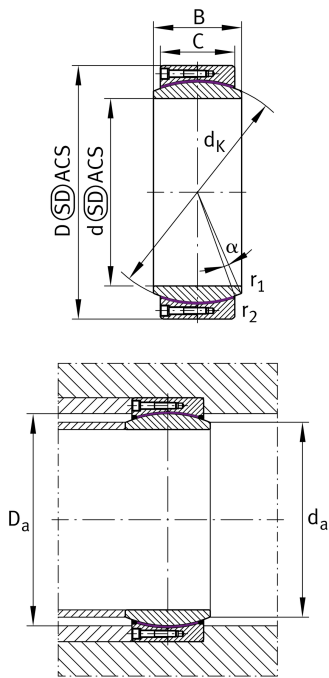

## Your current product variant

Maintenance	Maintenance free	
Sealing	Without	Without
Radial internal clearance	CN (Group N)	Normal internal clearance
Bore lining	Without	
Coating	G9	Outer ring- lateral surface hard chromium coated (Durotect CMT), bore tolerance H7
Fabric	GFK+PTFE	Glass fibre-reinforced sliding plastic plate with additives of PTFE
Material	Steel	

## Main Dimensions &amp; Performance Data

d	560 mm	Bore diameter bearing
$C_r$	8.500.000 N	Basic dynamic load rating, radial
D	750 mm	Outside diameter bearing
B	258 mm	Width inner ring
C	215 mm	Width Outer ring
$C_{0r}$	12.750.000 N	Basic static load rating, radial
$\approx m$	317 kg	Weight



### Mounting dimensions

$r_{1\text{min}}$	2 mm	Edge Spacing
$r_{2\text{min}}$	1 mm	Edge Spacing
$D_{\text{amin}}$	624 mm	Housing Connection Diameter
$d_{\text{amax}}$	602 mm	Connection measurement, inner ring

### Dimensions

$d_{\text{K}}$	655 mm	Ball diameter
$\alpha$	4 °	Tilt angle
$d_{\text{T}}$	H7	Bore diameter bearing, tolerance
$D_{\text{OT}}$	0 mm	Outside diameter, upper tolerance
$D_{\text{UT}}$	-0,07 mm	Outside diameter, lower tolerance
$B_{\text{OT}}$	0 mm	Width inner ring, upper tolerance
$d_{\text{UT}}$	0 mm	Bore diameter bearing, lower tolerance
$B_{\text{UT}}$	-0,4 mm	Width inner ring, lower tolerance
$d_{\text{OT}}$	0,07 mm	Bore diameter bearing, upper tolerance
$C_{\text{OT}}$	0 mm	Width outer ring, upper tolerance
$C_{\text{UT}}$	-0,4 mm	Width outer ring, lower tolerance
$G_{\text{r}}$	0,165-0,42	Radial Clearance
$G_{\text{rmax}}$	0,42 mm	Radial clearance, maximum
$G_{\text{rmin}}$	0,165 mm	Radial clearance, minimum









### Temperature range

$T_{\text{min}}$	-20 °C	Operating temperature min.
$T_{\text{max}}$	75 °C	Operating temperature max.



### Characteristics

---

-  Radial load
-  Axial load in one direction
-  Axial load in two directions
-  Lifetime lubrication, freedom from maintenance
-  Grease Lubrication
-  Not sealed
-  Large bearing
-  Static angular error and misalignment
-  Dynamic angular error and misalignment