

**GE280-FW-2RS**

Spherical plain bearing

Radial spherical plain bearing, maintenance-free, sliding layer: ELGOGLIDE, inner ring curved surface with hard chromium coating, DIN ISO 12240-1, dimension series G, sealed

Technical information

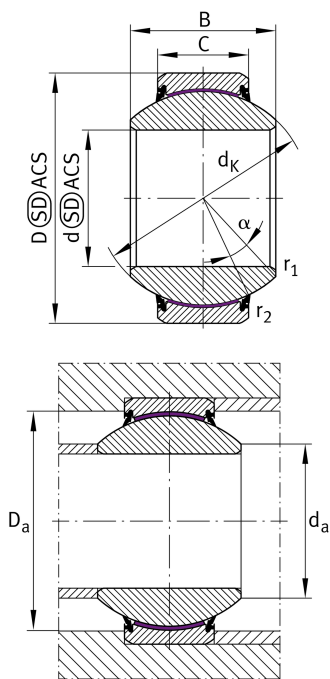

Your current product variant

Maintenance	Maintenance free
Type of Seal	2RS Lip seal on both sides
Bore lining	Without
Coating	Without
Fabric	ELGOGLIDE
Material	Steel

Main Dimensions & Performance Data

d	280 mm	Bore diameter bearing
C_r	10.800.000 N	Basic dynamic load rating, radial
D	430 mm	Outside diameter bearing
B	210 mm	Width inner ring
C	120 mm	Width Outer ring
C_{0r}	18.000.000 N	Basic static load rating, radial
$\approx m$	95,33 kg	Weight

Mounting dimensions

$r_{1\text{min}}$	1,1 mm	Edge Spacing
$r_{2\text{min}}$	1,1 mm	Edge Spacing
D_{amin}	370 mm	Housing Connection Diameter
d_{amax}	310,6 mm	Connection measurement, inner ring











Dimensions

d_K	375 mm	Ball diameter
α	15 °	Tilt angle
D_{OT}	0 mm	Outside diameter, upper tolerance
D_{UT}	-0,045 mm	Outside diameter, lower tolerance
B_{OT}	0 mm	Width inner ring, upper tolerance
d_{UT}	-0,035 mm	Bore diameter bearing, lower tolerance
B_{UT}	-0,35 mm	Width inner ring, lower tolerance
d_{OT}	0 mm	Bore diameter bearing, upper tolerance
C_{OT}	0 mm	Width outer ring, upper tolerance
C_{UT}	-0,9 mm	Width outer ring, lower tolerance
G_r	0 - 0,125	Radial Clearance
G_{rmax}	0,125 mm	Radial clearance, maximum
G_{rmin}	0 mm	Radial clearance, minimum

Temperature range

T_{min}	-30 °C	Operating temperature min.
T_{max}	130 °C	Operating temperature max.

Characteristics

	Radial load
	Axial load in one direction
	Axial load in two directions
	Lifetime lubrication, freedom from maintenance
	Sealed on both sides
	Large bearing
	Static angular error and misalignment
	Dynamic angular error and misalignment