

**GE90-FW-2RS**

Spherical plain bearing

Radial spherical plain bearing, maintenance-free, sliding layer: ELGOGLIDE, inner ring curved surface with hard chromium coating, DIN ISO 12240-1, dimension series G, sealed

Technical information

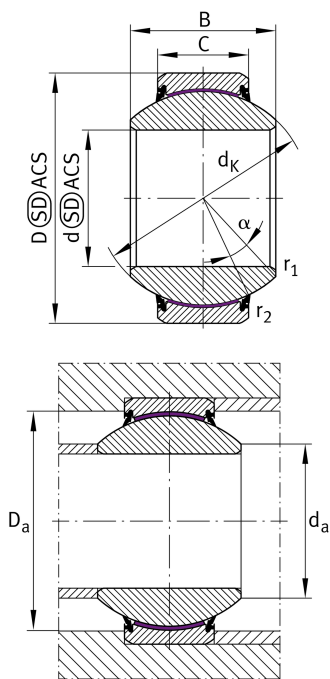

Your current product variant

Maintenance	Maintenance free
Type of Seal	2RS Lip seal on both sides
Bore lining	Without
Coating	Without
Fabric	ELGOGLIDE
Material	Steel

Main Dimensions & Performance Data

d	90 mm	Bore diameter bearing
C_r	1.720.000 N	Basic dynamic load rating, radial
D	150 mm	Outside diameter bearing
B	85 mm	Width inner ring
C	55 mm	Width Outer ring
C_{0r}	2.860.000 N	Basic static load rating, radial
$\approx m$	5,38 kg	Weight

Mounting dimensions

$r_{1\text{min}}$	1 mm	Edge Spacing
$r_{2\text{min}}$	1 mm	Edge Spacing
D_{amin}	123 mm	Housing Connection Diameter
d_{amax}	98,4 mm	Connection measurement, inner ring



Dimensions

d_K	130 mm	Ball diameter
α	15 °	Tilt angle
D_{OT}	0 mm	Outside diameter, upper tolerance
D_{UT}	-0,018 mm	Outside diameter, lower tolerance
B_{OT}	0 mm	Width inner ring, upper tolerance
d_{UT}	-0,02 mm	Bore diameter bearing, lower tolerance
B_{UT}	-0,2 mm	Width inner ring, lower tolerance
d_{OT}	0 mm	Bore diameter bearing, upper tolerance
C_{OT}	0 mm	Width outer ring, upper tolerance
C_{UT}	-0,5 mm	Width outer ring, lower tolerance
G_r	0 - 0,085	Radial Clearance
G_{rmax}	0,085 mm	Radial clearance, maximum
G_{rmin}	0 mm	Radial clearance, minimum

Temperature range

T_{min}	-30 °C	Operating temperature min.
T_{max}	130 °C	Operating temperature max.

Characteristics

	Radial load
	Axial load in one direction
	Axial load in two directions
	Lifetime lubrication, freedom from maintenance
	Sealed on both sides
	Static angular error and misalignment
	Dynamic angular error and misalignment