

**GE40-FW-2TS**

Spherical plain bearing

Radial spherical plain bearing, maintenance-free, sliding layer: ELGOGLIDE, inner ring curved surface with hard chromium coating, DIN ISO 12240-1, dimension series G, sealed

Technical information

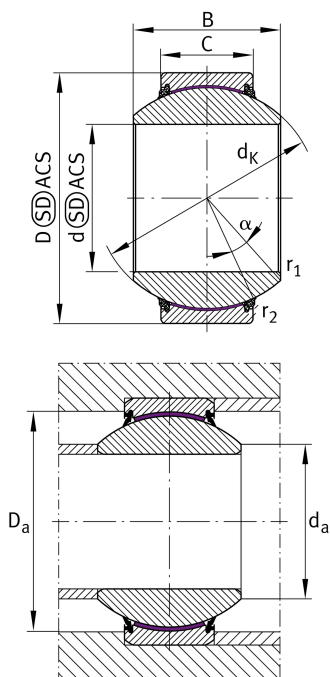

Your current product variant

Maintenance	Maintenance free	
Sealing	2TS	Integrated triple lip high performance seals on both sides
Bore lining	Without	
Coating	Without	
Fabric	ELGOGLIDE	
Material	Steel	

Main Dimensions & Performance Data

d	40 mm	Bore diameter bearing
C_r	360.000 N	Basic dynamic load rating, radial
D	68 mm	Outside diameter bearing
B	40 mm	Width inner ring
C	25 mm	Width Outer ring
C_{0r}	600.000 N	Basic static load rating, radial
m	0,516 kg	Weight

Mounting dimensions

$r_{1\text{min}}$	0,6 mm	Edge Spacing
$r_{2\text{min}}$	1 mm	Edge Spacing
D_{amin}	57 mm	Housing Connection Diameter
d_{amax}	44,7 mm	Connection measurement, inner ring









Dimensions

d_K	60 mm	Ball diameter
α	17 °	Tilt angle
D_{OT}	0 mm	Outside diameter, upper tolerance
D_{UT}	-0,013 mm	Outside diameter, lower tolerance
B_{OT}	0 mm	Width inner ring, upper tolerance
d_{UT}	-0,012 mm	Bore diameter bearing, lower tolerance
B_{UT}	-0,12 mm	Width inner ring, lower tolerance
d_{OT}	0 mm	Bore diameter bearing, upper tolerance
C_{OT}	0 mm	Width outer ring, upper tolerance
C_{UT}	-0,3 mm	Width outer ring, lower tolerance
G_r	0 - 0,06	Radial Clearance
G_{rmax}	0,06 mm	Radial clearance, maximum
G_{rmin}	0 mm	Radial clearance, minimum

Temperature range

T_{min}	-30 °C	Operating temperature min.
T_{max}	100 °C	Operating temperature max.

Characteristics

	Radial load
	Axial load in one direction
	Axial load in two directions
	Lifetime lubrication, freedom from maintenance
	Sealed on both sides
	Static angular error and misalignment