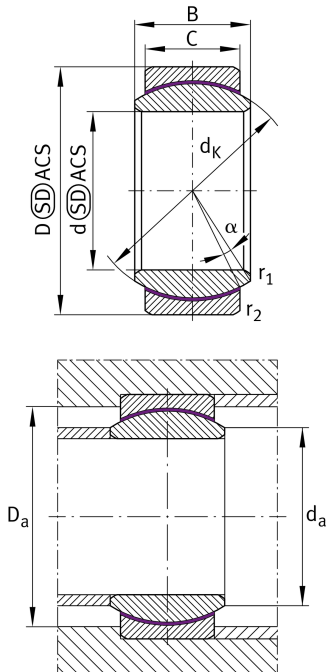

**GE17-UK**

Spherical plain bearing

Radial spherical plain bearing, maintenance-free, sliding layer: PTFE composite, inner ring curved surface with hard chromium coating, DIN ISO 12240-1, dimension series E, open design

Technical information

**Your current product variant**

Maintenance	Maintenance free	
Type of Seal	Without	Without
Bore lining	Without	
Coating	Without	
Fabric	PTFE-composite	Composite Material based on a steel backing, sintered bronze layer, with inserted plastic material.
Material	Steel	

Main Dimensions & Performance Data

d	17 mm	Bore diameter bearing
C _r	22.500 N	Basic dynamic load rating, radial
D	30 mm	Outside diameter bearing
B	14 mm	Width inner ring
C	10 mm	Width Outer ring
C _{0r}	56.300 N	Basic static load rating, radial
≈m	0,042 kg	Weight

Mounting dimensions

r _{1smin}	0,3 mm	Edge Spacing
r _{2smin}	0,3 mm	Edge Spacing
D _{amin}	24 mm	Housing Connection Diameter
d _{amax}	20,7 mm	Connection measurement, inner ring









Dimensions

d_K	25 mm	Ball diameter
α	10 °	Tilt angle
D_{OT}	0 mm	Outside diameter, upper tolerance
D_{UT}	-0,009 mm	Outside diameter, lower tolerance
B_{OT}	0 mm	Width inner ring, upper tolerance
d_{UT}	-0,008 mm	Bore diameter bearing, lower tolerance
B_{UT}	-0,12 mm	Width inner ring, lower tolerance
d_{OT}	0 mm	Bore diameter bearing, upper tolerance
C_{OT}	0 mm	Width outer ring, upper tolerance
C_{UT}	-0,24 mm	Width outer ring, lower tolerance
G_r	0 - 0,04	Radial Clearance
G_{rmax}	0,04 mm	Radial clearance, maximum
G_{rmin}	0 mm	Radial clearance, minimum

Temperature range

T_{min}	-50 °C	Operating temperature min.
T_{max}	200 °C	Operating temperature max.

Characteristics

	Radial load
	Axial load in one direction
	Axial load in two directions
	Lifetime lubrication, freedom from maintenance
	Not sealed
	Static angular error and misalignment
	Dynamic angular error and misalignment