

**GE140-UK-2TS**

## Spherical plain bearing

Radial spherical plain bearing, maintenance-free, sliding layer: ELGOGLIDE, DIN ISO 12240-1, Tolerances of the outside diameter and bore not according to DIN ISO 12240-1, dimension series E, sealed

## Technical information

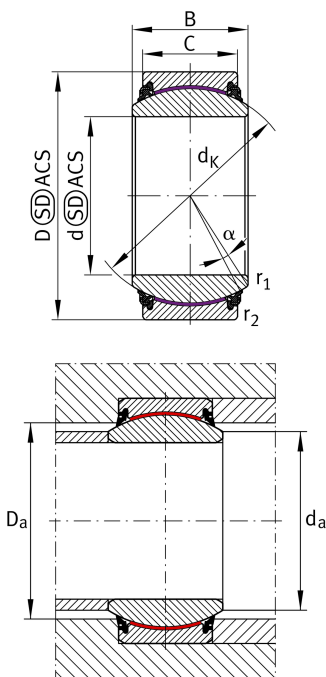

## Your current product variant

Maintenance	Maintenance free	
Type of Seal	2TS	Integrated triple lip high performance seals on both sides
Bore lining	Without	
Coating	Without	
Fabric	ELGOGLIDE	
Material	Steel	

## Main Dimensions &amp; Performance Data

d	140 mm	Bore diameter bearing
C <sub>r</sub>	3.020.000 N	Basic dynamic load rating, radial
D	210 mm	Outside diameter bearing
B	90 mm	Width inner ring
C	70 mm	Width Outer ring
C <sub>0r</sub>	5.040.000 N	Basic static load rating, radial
≈m	11,12 kg	Weight

## Mounting dimensions

r <sub>1smin</sub>	1 mm	Edge Spacing
r <sub>2smin</sub>	1 mm	Edge Spacing
D <sub>amin</sub>	173 mm	Housing Connection Diameter
d <sub>amax</sub>	155,9 mm	Connection measurement, inner ring



## Dimensions

$d_K$	180 mm	Ball diameter
$\alpha$	7 °	Tilt angle
$D_{OT}$	0 mm	Outside diameter, upper tolerance
$D_{UT}$	-0,03 mm	Outside diameter, lower tolerance
$B_{OT}$	0 mm	Width inner ring, upper tolerance
$d_{UT}$	-0,025 mm	Bore diameter bearing, lower tolerance
$B_{UT}$	-0,25 mm	Width inner ring, lower tolerance
$d_{OT}$	0 mm	Bore diameter bearing, upper tolerance
$C_{OT}$	0 mm	Width outer ring, upper tolerance
$C_{UT}$	-0,6 mm	Width outer ring, lower tolerance
$G_r$	0 - 0,085	Radial Clearance
$G_{rmax}$	0,085 mm	Radial clearance, maximum
$G_{rmin}$	0 mm	Radial clearance, minimum

## Temperature range

$T_{min}$	-30 °C	Operating temperature min.
$T_{max}$	100 °C	Operating temperature max.

## Characteristics

	Radial load
	Axial load in one direction
	Axial load in two directions
	Lifetime lubrication, freedom from maintenance
	Sealed on both sides
	Static angular error and misalignment
	Dynamic angular error and misalignment