

**GE320-DF-G9**

Spherical plain bearing

Radial spherical plain bearing, maintenance-free, sliding contact surface: GFK / hard chromium, DIN ISO 12240-1, dimension series C, open design

Technical information

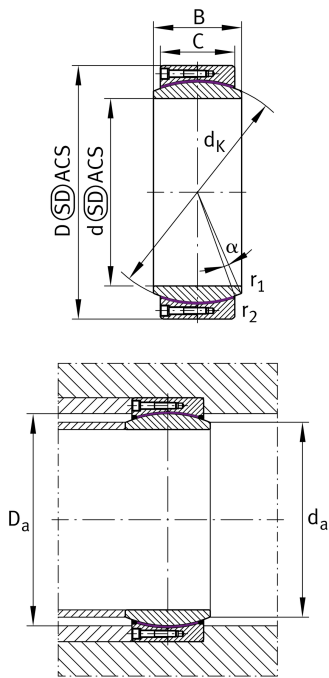

Your current product variant

Maintenance	Maintenance free	
Sealing	Without	Without
Radial internal clearance	CN (Group N)	Normal internal clearance
Bore lining	Without	
Coating	G9	Outer ring- lateral surface hard chromium coated (Durotect CMT), bore tolerance H7
Fabric	GFK+PTFE	Glass fibre-reinforced sliding plastic plate with additives of PTFE
Material	Steel	

Main Dimensions & Performance Data

d	320 mm	Bore diameter bearing
C_r	3.040.000 N	Basic dynamic load rating, radial
D	440 mm	Outside diameter bearing
B	160 mm	Width inner ring
C	135 mm	Width Outer ring
C_{0r}	4.560.000 N	Basic static load rating, radial
≈m	69 kg	Weight



Mounting dimensions

$r_{1\text{min}}$	1,1 mm	Edge Spacing
$r_{2\text{min}}$	1 mm	Edge Spacing
D_{amin}	361 mm	Housing Connection Diameter
d_{amax}	344,7 mm	Connection measurement, inner ring

Dimensions









d_{K}	380 mm	Ball diameter
α	4 °	Tilt angle
d_{T}	H7	Bore diameter bearing, tolerance
D_{OT}	0 mm	Outside diameter, upper tolerance
D_{UT}	-0,06 mm	Outside diameter, lower tolerance
B_{OT}	0 mm	Width inner ring, upper tolerance
d_{UT}	0 mm	Bore diameter bearing, lower tolerance
B_{UT}	-0,4 mm	Width inner ring, lower tolerance
d_{OT}	0,057 mm	Bore diameter bearing, upper tolerance
C_{OT}	0 mm	Width outer ring, upper tolerance
C_{UT}	-0,4 mm	Width outer ring, lower tolerance
G_{r}	0,125-0,34	Radial Clearance
G_{rmax}	0,34 mm	Radial clearance, maximum
G_{rmin}	0,125 mm	Radial clearance, minimum

Temperature range

T_{min}	-20 °C	Operating temperature min.
T_{max}	75 °C	Operating temperature max.



Characteristics

-  Radial load
-  Axial load in one direction
-  Axial load in two directions
-  Lifetime lubrication, freedom from maintenance
-  Grease Lubrication
-  Not sealed
-  Large bearing
-  Static angular error and misalignment
-  Dynamic angular error and misalignment