

**GE25-DO-HLN**

Spherical plain bearing

Standard performance Radial spherical plain bearing, requiring maintenance, sliding contact surface: steel/steel, DIN ISO 12240-1, dimension series E, open design

Technical information

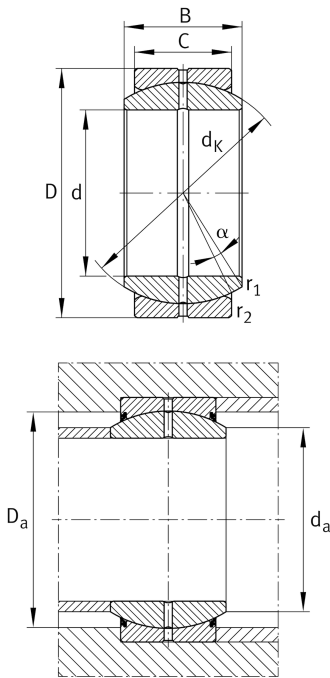

Your current product variant

Maintenance	Maintenance required
Material	Steel
Type of Seal	Without
Radial internal clearance	CN (Group N) Normal internal clearance
Coating	Durotect M Inner- and outer ring coated with Durotect M (Manganese Phosphate)

Main Dimensions & Performance Data

d	25 mm	Bore diameter bearing
D	42 mm	Outside diameter bearing
B	20 mm	Width inner ring
C _r	48.300 N	Basic dynamic load rating, radial
C _{0r}	241.000 N	Basic static load rating, radial
≈m	0,109 kg	Weight

Mounting dimensions

r _{1smin}	0,6 mm	Edge Spacing
r _{2smin}	0,6 mm	Edge Spacing
d _{a max}	29,3 mm	Connection measure Inner ring
D _{a min}	33 mm	Housing Connection Diameter









Dimensions

C	16 mm	Width Outer ring
d_K	35,5 mm	Ball diameter
α	7 °	Tilt angle
d_{OT}	0 mm	Bore diameter bearing, upper tolerance
d_{UT}	-0,01 mm	Bore diameter bearing, lower tolerance
D_{OT}	0 mm	Outside diameter, upper tolerance
D_{UT}	-0,011 mm	Outside diameter, lower tolerance
B_{OT}	0 mm	Width inner ring, upper tolerance
B_{UT}	-0,12 mm	Width inner ring, lower tolerance
C_{OT}	0 mm	Width outer ring, upper tolerance
C_{UT}	-0,24 mm	Width outer ring, lower tolerance
G_r	0,05 - 0,1	Radial Clearance
G_{rmax}	0,1 mm	Radial clearance, maximum
G_{rmin}	0,05 mm	Radial clearance, minimum

Temperature range

T_{min}	-60 °C	Operating temperature min.
T_{max}	200 °C	Operating temperature max.

Characteristics

-  Radial load
-  Axial load in one direction
-  Axial load in two directions
-  Grease Lubrication
-  Sealed on both sides
-  Static angular error and misalignment
-  Dynamic angular error and misalignment