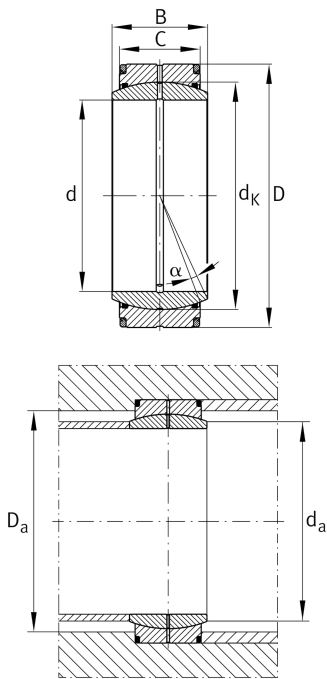

**GE360-DO-2RS4**

Spherical plain bearing

Radial spherical plain bearing, requiring maintenance, sliding contact surface: steel/steel; DIN ISO 12240-1, dimension series C, sealed

Technical information

**Your current product variant**

Maintenance	Maintenance required	
Material	Steel	
Type of Seal	2RS4	Lip seals with increased sealing action on both sides
Radial internal clearance	CN (Group N)	Normal internal clearance
Coating	Durotect M	Inner- and outer ring coated with Durotect M (Manganese Phosphate)

Main Dimensions & Performance Data

d	360 mm	Bore diameter bearing
D	480 mm	Outside diameter bearing
B	160 mm	Width inner ring
C _r	5.660.000 N	Basic dynamic load rating, radial
C _{0r}	21.800.000 N	Basic static load rating, radial
m	84,9 kg	Weight

Mounting dimensions

r _{1smin}	1,1 mm	Edge Spacing
r _{2smin}	3 mm	Edge Spacing
d _{a max}	388,3 mm	Connection measure Inner ring
D _{a min}	403 mm	Housing Connection Diameter



Dimensions

C	135 mm	Width Outer ring
d _K	420 mm	Ball diameter
α	3,6 °	Tilt angle
d _{OT}	0 mm	Bore diameter bearing, upper tolerance
d _{UT}	-0,04 mm	Bore diameter bearing, lower tolerance
D _{OT}	0 mm	Outside diameter, upper tolerance
D _{UT}	-0,045 mm	Outside diameter, lower tolerance
B _{OT}	0 mm	Width inner ring, upper tolerance
B _{UT}	-0,4 mm	Width inner ring, lower tolerance
C _{OT}	0 mm	Width outer ring, upper tolerance
C _{UT}	-0,9 mm	Width outer ring, lower tolerance
G _r	0,135 - 0,261	Radial Clearance
G _{rmax}	0,261 mm	Radial clearance, maximum
G _{rmin}	0,135 mm	Radial clearance, minimum

Temperature range

T _{min}	-30 °C	Operating temperature min.
T _{max}	130 °C	Operating temperature max.



Characteristics



Radial load



Axial load in one direction



Axial load in two directions



Grease Lubrication



Sealed on both sides



Large bearing



Static angular error and misalignment



Dynamic angular error and misalignment