

**GE100-FO-2RS**

Spherical plain bearing

High performance Radial spherical plain bearing, requiring maintenance, sliding contact surface: steel/steel, DIN ISO 12240-1, dimension series G, sealed High-performance: For highest load rating and lifetime demands

Technical information

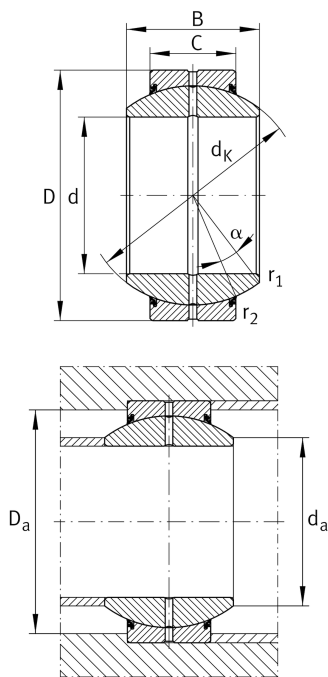

Your current product variant

Maintenance	Maintenance required	
Material	Steel	
Type of Seal	2RS	Lip seals on both sides
Radial internal clearance	CN (Group N)	Normal internal clearance
Coating	Durotect M	Inner- and outer ring coated with Durotect M (Manganese Phosphate)

Main Dimensions & Performance Data

d	100 mm	Bore diameter bearing
D	160 mm	Outside diameter bearing
B	85 mm	Width inner ring
C _r	851.000 N	Basic dynamic load rating, radial
C _{0r}	3.270.000 N	Basic static load rating, radial
≈m	5,86 kg	Weight

Mounting dimensions

r _{1smin}	1 mm	Edge Spacing
r _{2smin}	1 mm	Edge Spacing
d _{a max}	111,2 mm	Connection measure Inner ring
D _{a min}	134 mm	Housing Connection Diameter









Dimensions

C	55 mm	Width Outer ring
d _K	140 mm	Ball diameter
α	14 °	Tilt angle
d _{OT}	0 mm	Bore diameter bearing, upper tolerance
d _{UT}	-0,02 mm	Bore diameter bearing, lower tolerance
D _{OT}	0 mm	Outside diameter, upper tolerance
D _{UT}	-0,025 mm	Outside diameter, lower tolerance
B _{OT}	0 mm	Width inner ring, upper tolerance
B _{UT}	-0,2 mm	Width inner ring, lower tolerance
C _{OT}	0 mm	Width outer ring, upper tolerance
C _{UT}	-0,5 mm	Width outer ring, lower tolerance
G _r	0,085 - 0,165	Radial Clearance
G _{rmax}	0,165 mm	Radial clearance, maximum
G _{rmin}	0,085 mm	Radial clearance, minimum

Temperature range

T _{min}	-30 °C	Operating temperature min.
T _{max}	130 °C	Operating temperature max.

Characteristics

-  Radial load
-  Axial load in one direction
-  Axial load in two directions
-  Grease Lubrication
-  Sealed on both sides
-  Static angular error and misalignment
-  Dynamic angular error and misalignment