

**GE30-FO-2TS**

Spherical plain bearing

High performance Radial spherical plain bearing, requiring maintenance, sliding contact surface: steel/steel, DIN ISO 12240-1, dimension series G, sealed High-performance: For highest load rating and lifetime demands

Technical information

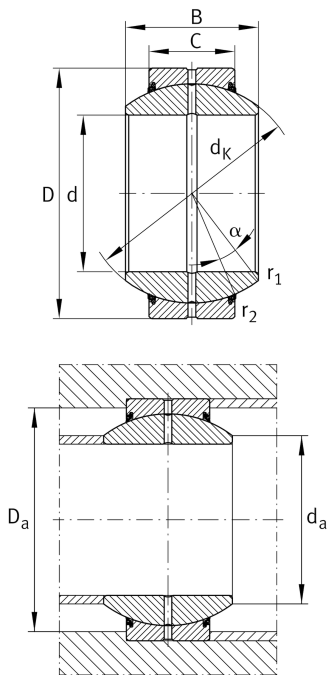

Your current product variant

Maintenance	Maintenance required	
Material	Steel	
Type of Seal	2TS	Integrated triple lip high performance seals on both sides
Radial internal clearance	CN (Group N)	Normal internal clearance
Coating	Durotect M	Inner- and outer ring coated with Durotect M (Manganese Phosphate)

Main Dimensions & Performance Data

d	30 mm	Bore diameter bearing
D	55 mm	Outside diameter bearing
B	32 mm	Width inner ring
C _r	104.000 N	Basic dynamic load rating, radial
C _{0r}	400.000 N	Basic static load rating, radial
m	0,286 kg	Weight

Mounting dimensions

r _{1min}	0,6 mm	Edge Spacing
r _{2min}	1 mm	Edge Spacing
d _{a max}	34,4 mm	Connection measure Inner ring
D _{a min}	44,5 mm	Housing Connection Diameter



Dimensions

C	20 mm	Width Outer ring
d_K	47 mm	Ball diameter
α	17 °	Tilt angle
d_{OT}	0 mm	Bore diameter bearing, upper tolerance
d_{UT}	-0,01 mm	Bore diameter bearing, lower tolerance
D_{OT}	0 mm	Outside diameter, upper tolerance
D_{UT}	-0,013 mm	Outside diameter, lower tolerance
B_{OT}	0 mm	Width inner ring, upper tolerance
B_{UT}	-0,12 mm	Width inner ring, lower tolerance
C_{OT}	0 mm	Width outer ring, upper tolerance
C_{UT}	-0,3 mm	Width outer ring, lower tolerance
G_r	0,05 - 0,1	Radial Clearance
G_{rmax}	0,1 mm	Radial clearance, maximum
G_{rmin}	0,05 mm	Radial clearance, minimum

Temperature range

T_{min}	-30 °C	Operating temperature min.
T_{max}	100 °C	Operating temperature max.

Characteristics

	Radial load
	Axial load in one direction
	Axial load in two directions
	Grease Lubrication
	Sealed on both sides
	Static angular error and misalignment
	Dynamic angular error and misalignment