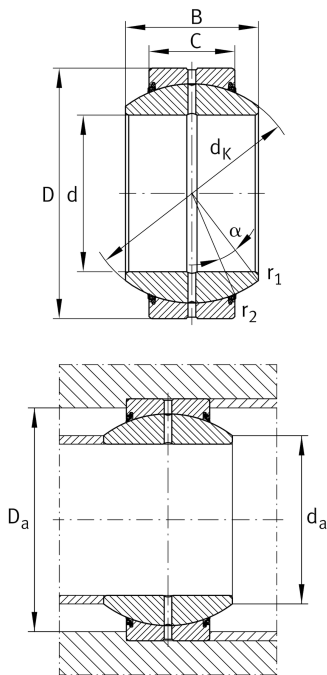

**GE60-FO-2TS**

Spherical plain bearing

High performance Radial spherical plain bearing, requiring maintenance, sliding contact surface: steel/steel, DIN ISO 12240-1, dimension series G, sealed High-performance: For highest load rating and lifetime demands

Technical information

**Your current product variant**

Maintenance	Maintenance required	
Material	Steel	
Type of Seal	2TS	Integrated triple lip high performance seals on both sides
Radial internal clearance	CN (Group N)	Normal internal clearance
Coating	Durotect M	Inner- and outer ring coated with Durotect M (Manganese Phosphate)

Main Dimensions & Performance Data

d	60 mm	Bore diameter bearing
D	105 mm	Outside diameter bearing
B	63 mm	Width inner ring
C _r	407.000 N	Basic dynamic load rating, radial
C _{0r}	1.560.000 N	Basic static load rating, radial
m	2,03 kg	Weight

Mounting dimensions

r _{1smin}	1 mm	Edge Spacing
r _{2smin}	1 mm	Edge Spacing
d _{a max}	67 mm	Connection measure Inner ring
D _{a min}	87 mm	Housing Connection Diameter









Dimensions

C	40 mm	Width Outer ring
d_K	92 mm	Ball diameter
α	17 °	Tilt angle
d_{OT}	0 mm	Bore diameter bearing, upper tolerance
d_{UT}	-0,015 mm	Bore diameter bearing, lower tolerance
D_{OT}	0 mm	Outside diameter, upper tolerance
D_{UT}	-0,015 mm	Outside diameter, lower tolerance
B_{OT}	0 mm	Width inner ring, upper tolerance
B_{UT}	-0,15 mm	Width inner ring, lower tolerance
C_{OT}	0 mm	Width outer ring, upper tolerance
C_{UT}	-0,4 mm	Width outer ring, lower tolerance
G_r	0,072 - 0,142	Radial Clearance
G_{rmax}	0,142 mm	Radial clearance, maximum
G_{rmin}	0,072 mm	Radial clearance, minimum

Temperature range

T_{min}	-30 °C	Operating temperature min.
T_{max}	100 °C	Operating temperature max.

Characteristics

-  Radial load
-  Axial load in one direction
-  Axial load in two directions
-  Grease Lubrication
-  Sealed on both sides
-  Static angular error and misalignment
-  Dynamic angular error and misalignment