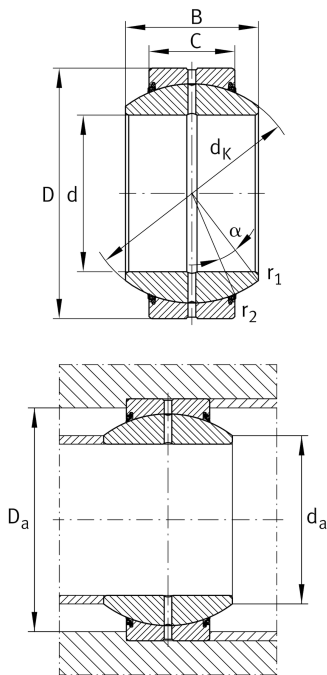

**GE70-FO-2TS**

Spherical plain bearing

High performance Radial spherical plain bearing, requiring maintenance, sliding contact surface: steel/steel, DIN ISO 12240-1, dimension series G, sealed High-performance: For highest load rating and lifetime demands

Technical information

**Your current product variant**

Maintenance	Maintenance required	
Material	Steel	
Sealing	2TS	Integrated triple lip high performance seals on both sides
Radial internal clearance	CN (Group N)	Normal internal clearance
Coating	Durotect M	Inner- and outer ring coated with Durotect M (Manganese Phosphate)

Main Dimensions & Performance Data

d	70 mm	Bore diameter bearing
D	120 mm	Outside diameter bearing
B	70 mm	Width inner ring
C _r	522.000 N	Basic dynamic load rating, radial
C _{0r}	2.010.000 N	Basic static load rating, radial
m	2,929 kg	Weight

Mounting dimensions

r _{1smin}	1 mm	Edge Spacing
r _{2smin}	1 mm	Edge Spacing
d _{a max}	78,2 mm	Connection measure Inner ring
D _{a min}	99 mm	Housing Connection Diameter



Dimensions

C	45 mm	Width Outer ring
d _K	105 mm	Ball diameter
α	16 °	Tilt angle
d _{OT}	0 mm	Bore diameter bearing, upper tolerance
d _{UT}	-0,015 mm	Bore diameter bearing, lower tolerance
D _{OT}	0 mm	Outside diameter, upper tolerance
D _{UT}	-0,015 mm	Outside diameter, lower tolerance
B _{OT}	0 mm	Width inner ring, upper tolerance
B _{UT}	-0,15 mm	Width inner ring, lower tolerance
C _{OT}	0 mm	Width outer ring, upper tolerance
C _{UT}	-0,4 mm	Width outer ring, lower tolerance
G _r	0,072 - 0,142	Radial Clearance
G _{rmax}	0,142 mm	Radial clearance, maximum
G _{rmin}	0,072 mm	Radial clearance, minimum

Temperature range

T _{min}	-30 °C	Operating temperature min.
T _{max}	100 °C	Operating temperature max.

Characteristics

	Radial load
	Axial load in one direction
	Axial load in two directions
	Grease Lubrication
	Sealed on both sides
	Static angular error and misalignment
	Dynamic angular error and misalignment