

**GE30-PB**

## Spherical plain bearing



Radial spherical plain bearing, requiring maintenance, sliding contact surface: steel/bronze, DIN ISO 12240-1, dimension series K, open design

## Technical information

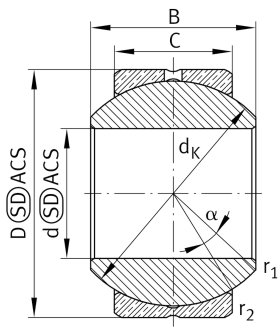

## Your current product variant

Maintenance	Maintenance required
Material	Steel
Sealing	Without
Radial internal clearance	CN (Group N) Normal internal clearance
Coating	Without

## Main Dimensions &amp; Performance Data

d	30 mm	Bore diameter bearing
D	55 mm	Outside diameter bearing
B	37 mm	Width inner ring
$C_r$	63.500 N	Basic dynamic load rating, radial
$C_{0r}$	159.000 N	Basic static load rating, radial
$\approx m$	0,385 kg	Weight

## Mounting dimensions

$r_{1\text{min}}$	0,3 mm	Edge Spacing
$r_{2\text{min}}$	0,6 mm	Edge Spacing
$d_{a\text{max}}$	34,8 mm	Connection measure Inner ring
$D_{a\text{min}}$	46 mm	Housing Connection Diameter



### Dimensions

C	25 mm	Width Outer ring
d <sub>K</sub>	50,8 mm	Ball diameter
α	17 °	Tilt angle
d <sub>OT</sub>	0,021 mm	Bore diameter bearing, upper tolerance
d <sub>UT</sub>	0 mm	Bore diameter bearing, lower tolerance
d <sub>T</sub>	H7	Bore diameter bearing, tolerance
D <sub>OT</sub>	0 mm	Outside diameter, upper tolerance
D <sub>UT</sub>	-0,013 mm	Outside diameter, lower tolerance
B <sub>OT</sub>	0 mm	Width inner ring, upper tolerance
B <sub>UT</sub>	-0,12 mm	Width inner ring, lower tolerance
C <sub>OT</sub>	0 mm	Width outer ring, upper tolerance
C <sub>UT</sub>	-0,3 mm	Width outer ring, lower tolerance
G <sub>r</sub>	0,006 - 0,035	Radial Clearance
G <sub>rmax</sub>	0,035 mm	Radial clearance, maximum
G <sub>rmin</sub>	0,006 mm	Radial clearance, minimum

### Temperature range

T <sub>min</sub>	-60 °C	Operating temperature min.
T <sub>max</sub>	250 °C	Operating temperature max.



### Characteristics

---



Radial load



Axial load in one direction



Axial load in two directions



Grease Lubrication



Not sealed



Static angular error and misalignment



Dynamic angular error and misalignment