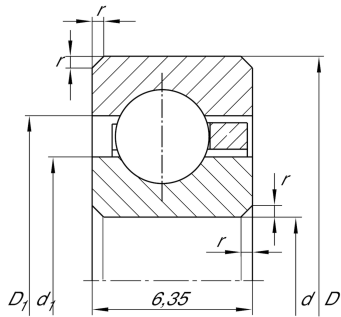

**CSCA065**

Deep groove ball bearing

Deep groove ball bearing, Thin section bearing CSCA, brass sheet metal cage

Technical information

**Your current product variant**

Logistical code	HLE	-
Type of Seal	Without	Not sealed
Cage	YH	Brass sheet metal
Dimensional / heat stabilization	SN	Rings dimensional stabilized up to 120°
Tolerance class	PL1	Class PL1, Normal
Radial internal clearance	PL1	Class PL1, Normal
Lubricant	Without	Bearing not greased

Main Dimensions & Performance Data

d	165,1 mm	Bore diameter
D	177,8 mm	Outside diameter
B	6,35 mm	Width
C_r	5.000 N	Basic dynamic load rating, radial
C_{0r}	8.300 N	Basic static load rating, radial
n_G	3.350 1/min	Limiting speed
m	140 g	Weight



Dimensions

r_{\min}	0,6 mm	Minimum chamfer dimension
d_1	169,8 mm	Shoulder diameter inner ring
D_1	173,1 mm	Shoulder diameter outer ring

Temperature range

T_{\min}	-30 °C	Operating temperature min.
T_{\max}	120 °C	Operating temperature max.

Characteristics

-  Radial load
-  Axial load in one direction
-  Axial load in two directions
-  Grease Lubrication
-  Oil Lubrication
-  Not sealed