

**CSCA080**

Deep groove ball bearing

Deep groove ball bearing, Thin section bearing CSCA, brass sheet metal cage

Technical information

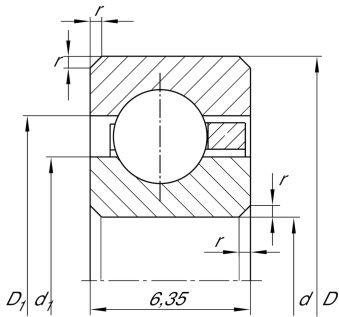

Your current product variant

Logistical code	HLE	-
Sealing	Without	Not sealed
Cage	YH	Brass sheet metal
Dimensional / heat stabilization	SN	Rings dimensional stabilized up to 120°
Tolerance class	PL1	Class PL1, Normal
Radial internal clearance	PL1	Class PL1, Normal
Lubricant	Without	Bearing not greased

Main Dimensions & Performance Data

d	203,2 mm	Bore diameter
D	215,9 mm	Outside diameter
B	6,35 mm	Width
C_r	5.400 N	Basic dynamic load rating, radial
C_{0r}	10.200 N	Basic static load rating, radial
n_G	2.700 1/min	Limiting speed
$\approx m$	170 g	Weight



Dimensions

r_{\min}	0,6 mm	Minimum chamfer dimension
d_1	207,9 mm	Shoulder diameter inner ring
D_1	211,2 mm	Shoulder diameter outer ring

Temperature range

T_{\min}	-30 °C	Operating temperature min.
T_{\max}	120 °C	Operating temperature max.

Characteristics

-  Radial load
-  Axial load in one direction
-  Axial load in two directions
-  Grease Lubrication
-  Oil Lubrication
-  Not sealed