

**CSCB020**

## Deep groove ball bearing

Deep groove ball bearing, Thin section bearing CSCB, brass sheet metal cage

## Technical information

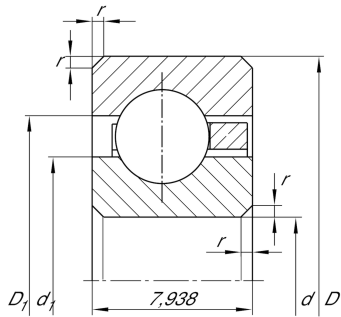

## Your current product variant

Logistical code	HLE	-
Type of Seal	Without	Not sealed
Cage	YH	Brass sheet metal
Dimensional / heat stabilization	SN	Rings dimensional stabilized up to 120°
Tolerance class	PL1	Class PL1, Normal
Radial internal clearance	PL1	Class PL1, Normal
Lubricant	Without	Bearing not greased

## Main Dimensions &amp; Performance Data

d	50,8 mm	Bore diameter
D	66,675 mm	Outside diameter
B	7,938 mm	Width
$C_r$	4.750 N	Basic dynamic load rating, radial
$C_{0r}$	3.550 N	Basic static load rating, radial
$n_G$	9.900 1/min	Limiting speed
$m$	70 g	Weight



### Dimensions

$r_{\min}$	1 mm	Minimum chamfer dimension
$d_1$	56,7 mm	Shoulder diameter inner ring
$D_1$	60,8 mm	Shoulder diameter outer ring

### Temperature range

$T_{\min}$	-30 °C	Operating temperature min.
$T_{\max}$	120 °C	Operating temperature max.

### Characteristics

-  Radial load
-  Axial load in one direction
-  Axial load in two directions
-  Grease Lubrication
-  Oil Lubrication
-  Not sealed