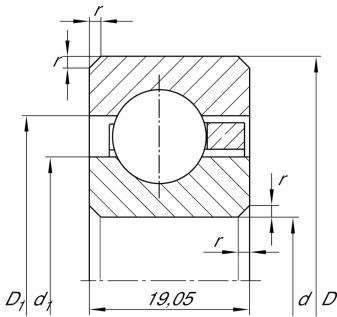

**CSCF065** [↗](#)

Deep groove ball bearing

Deep groove ball bearing, Thin section bearing CSCF, brass sheet metal cage

Technical information

**Your current product variant**

Logistical code	HLE	-
Sealing	Without	Not sealed
Cage	YH	Brass sheet metal
Dimensional / heat stabilization	SN	Rings dimensional stabilized up to 120°
Tolerance class	PL1	Class PL1, Normal
Radial internal clearance	PL1	Class PL1, Normal
Lubricant	Without	Bearing not greased

Main Dimensions & Performance Data

d	165,1 mm	Bore diameter
D	203,2 mm	Outside diameter
B	19,05 mm	Width
C _r	28.000 N	Basic dynamic load rating, radial
C _{0r}	31.500 N	Basic static load rating, radial
n _G	2.950 1/min	Limiting speed
m	1,32 kg	Weight









Dimensions

r_{min}	2 mm	Minimum chamfer dimension
d_1	179,2 mm	Shoulder diameter inner ring
D_1	189,1 mm	Shoulder diameter outer ring

Temperature range

T_{min}	-30 °C	Operating temperature min.
T_{max}	120 °C	Operating temperature max.

Characteristics

-  Radial load
-  Axial load in one direction
-  Axial load in two directions
-  Grease Lubrication
-  Oil Lubrication
-  Not sealed