

**CSCG140**

## Deep groove ball bearing

Deep groove ball bearing, Thin section bearing CSCG, brass sheet metal cage

## Technical information

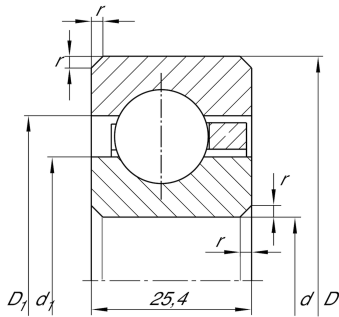

## Your current product variant

Logistical code	HLE	-
Sealing	Without	Not sealed
Cage	YH	Brass sheet metal
Dimensional / heat stabilization	SN	Rings dimensional stabilized up to 120°
Tolerance class	PL1	Class PL1, Normal
Radial internal clearance	PL1	Class PL1, Normal
Lubricant	Without	Bearing not greased

## Main Dimensions &amp; Performance Data

d	355,6 mm	Bore diameter
D	406,4 mm	Outside diameter
B	25,4 mm	Width
C <sub>r</sub>	55.000 N	Basic dynamic load rating, radial
C <sub>0r</sub>	98.000 N	Basic static load rating, radial
n <sub>G</sub>	1.380 1/min	Limiting speed
≈m	4,89 kg	Weight









### Dimensions

$r_{min}$	2 mm	Minimum chamfer dimension
$d_1$	374,5 mm	Shoulder diameter inner ring
$D_1$	387,6 mm	Shoulder diameter outer ring

### Temperature range

$T_{min}$	-30 °C	Operating temperature min.
$T_{max}$	120 °C	Operating temperature max.

### Characteristics

-  Radial load
-  Axial load in one direction
-  Axial load in two directions
-  Grease Lubrication
-  Oil Lubrication
-  Not sealed
-  Large bearing