

**CSCG180**

Deep groove ball bearing

Deep groove ball bearing, Thin section bearing CSCG, brass sheet metal cage

Technical information

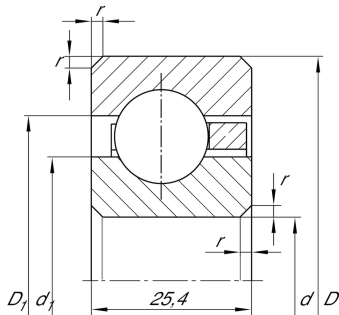

Your current product variant

Logistical code	HLE	-
Sealing	Without	Not sealed
Cage	YH	Brass sheet metal
Dimensional / heat stabilization	SN	Rings dimensional stabilized up to 120°
Tolerance class	PL1	Class PL1, Normal
Radial internal clearance	PL1	Class PL1, Normal
Lubricant	Without	Bearing not greased

Main Dimensions & Performance Data

d	457,2 mm	Bore diameter
D	508 mm	Outside diameter
B	25,4 mm	Width
C _r	60.000 N	Basic dynamic load rating, radial
C _{0r}	126.000 N	Basic static load rating, radial
n _G	1.080 1/min	Limiting speed
m	6,21 kg	Weight









Dimensions

r_{min}	2 mm	Minimum chamfer dimension
d_1	476,1 mm	Shoulder diameter inner ring
D_1	489,2 mm	Shoulder diameter outer ring

Temperature range

T_{min}	-30 °C	Operating temperature min.
T_{max}	120 °C	Operating temperature max.

Characteristics

-  Radial load
-  Axial load in one direction
-  Axial load in two directions
-  Grease Lubrication
-  Oil Lubrication
-  Not sealed
-  Large bearing