

**CSCU045-2RS**

## Deep groove ball bearing

Deep groove ball bearing, Thin section bearing CSCU...-2RS, seals, brass sheet metal cage

## Technical information

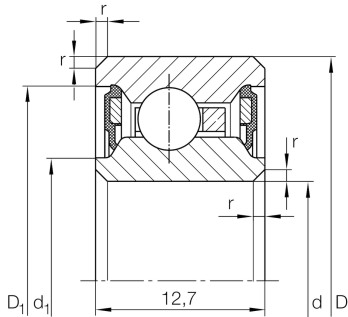

## Your current product variant

Logistical code	HLE	-
Sealing	2RS	Contact seal on both sides
Cage	YH	Brass sheet metal
Dimensional / heat stabilization	SN	Rings dimensional stabilized up to 120°
Tolerance class	PL1	Class PL1, Normal
Radial internal clearance	PL1	Class PL1, Normal
Lubricant	Lubricating grease	

## Main Dimensions &amp; Performance Data

d	114,3 mm	Bore diameter
D	133,35 mm	Outside diameter
B	12,7 mm	Width
$C_r$	8.200 N	Basic dynamic load rating, radial
$C_{0r}$	9.200 N	Basic static load rating, radial
$n_G$	2.250 1/min	Limiting speed
$m$	280 g	Weight









### Dimensions

$r_{min}$	0,38 mm	Minimum chamfer dimension
$d_1$	121,3 mm	Shoulder diameter inner ring
$D_1$	126,3 mm	Shoulder diameter outer ring
$d_1$	118,1 mm	Caliber diameter inner ring
$D_1$	128,2 mm	Caliber diameter outer ring

### Temperature range

$T_{min}$	-25 °C	Operating temperature min.
$T_{max}$	120 °C	Operating temperature max.

### Characteristics

-   $F_r$  Radial load
-   $F_a$  Axial load in one direction
-   $F_a$  Axial load in two directions
-   $L_h$  Lifetime lubrication, freedom from maintenance
-  Grease Lubrication
-  Sealed on both sides