

**CSCU075-2RS**

Deep groove ball bearing

Deep groove ball bearing, Thin section bearing CSCU...-2RS, seals, brass sheet metal cage

Technical information

Your current product variant

Logistical code	HLE	-
Type of Seal	2RS	Contact seal on both sides
Cage	YH	Brass sheet metal
Dimensional / heat stabilization	SN	Rings dimensional stabilized up to 120°
Tolerance class	PL1	Class PL1, Normal
Radial internal clearance	PL1	Class PL1, Normal
Lubricant	Lubricating grease	

Main Dimensions & Performance Data

d	190,5 mm	Bore diameter
D	209,55 mm	Outside diameter
B	12,7 mm	Width
C _r	9.800 N	Basic dynamic load rating, radial
C _{0r}	15.200 N	Basic static load rating, radial
n _G	1.370 1/min	Limiting speed
≈m	450 g	Weight

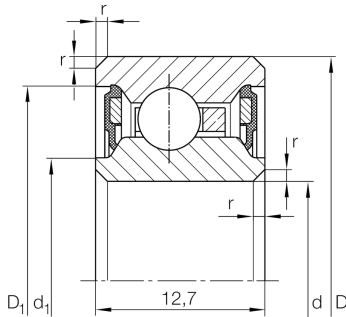









Dimensions

r_{min}	0,38 mm	Minimum chamfer dimension
d_1	197,5 mm	Shoulder diameter inner ring
D_1	202,5 mm	Shoulder diameter outer ring
d_1	194,3 mm	Caliber diameter inner ring
D_1	204,1 mm	Caliber diameter outer ring

Temperature range

T_{min}	-25 °C	Operating temperature min.
T_{max}	120 °C	Operating temperature max.

Characteristics

-  F_r Radial load
-  F_a Axial load in one direction
-  F_a Axial load in two directions
-  L_h Lifetime lubrication, freedom from maintenance
-  Grease Lubrication
-  Sealed on both sides