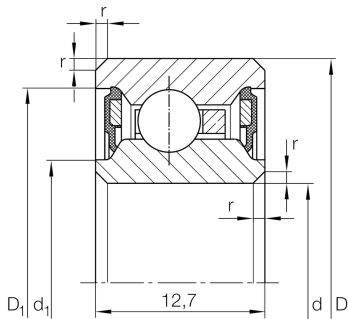

**CSCU110-2RS**

Deep groove ball bearing

Deep groove ball bearing, Thin section bearing CSCU...-2RS, seals, brass sheet metal cage

Technical information

**Your current product variant**

Logistical code	HLE	-
Type of Seal	2RS	Contact seal on both sides
Cage	YH	Brass sheet metal
Dimensional / heat stabilization	SN	Rings dimensional stabilized up to 120°
Tolerance class	PL1	Class PL1, Normal
Radial internal clearance	PL1	Class PL1, Normal
Lubricant	Lubricating grease	

Main Dimensions & Performance Data

d	279,4 mm	Bore diameter
D	298,45 mm	Outside diameter
B	12,7 mm	Width
C _r	11.200 N	Basic dynamic load rating, radial
C _{0r}	22.200 N	Basic static load rating, radial
n _G	940 1/min	Limiting speed
≈m	0,65 kg	Weight









Dimensions

r_{min}	0,38 mm	Minimum chamfer dimension
d_1	286,4 mm	Shoulder diameter inner ring
D_1	291,4 mm	Shoulder diameter outer ring
d_1	283,2 mm	Caliber diameter inner ring
D_1	293 mm	Caliber diameter outer ring

Temperature range

T_{min}	-25 °C	Operating temperature min.
T_{max}	120 °C	Operating temperature max.

Characteristics

-  F_r Radial load
-  F_a Axial load in one direction
-  F_a Axial load in two directions
-  L_h Lifetime lubrication, freedom from maintenance
-  Grease Lubrication
-  Sealed on both sides