

**CSEA065**

Angular contact ball bearing

Angular contact ball bearing, Thin section bearing CSEA, brass sheet metal cage

Technical information

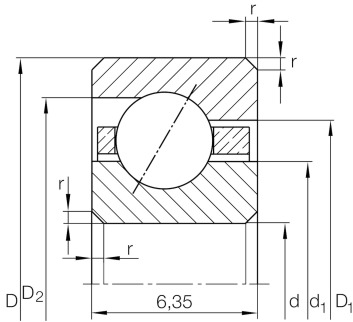

Your current product variant

Logistical code	HLE	-
Sealing	Without	Not sealed
Cage	YP	Brass sheet metal
Tolerance class	PL1	Class PL1, Normal
Lubricant	Without	Bearing not greased

Main Dimensions & Performance Data

d	165,1 mm	Bore diameter
D	177,8 mm	Outside diameter
B	6,35 mm	Width
C _r	4.950 N	Basic dynamic load rating, radial
C _{0r}	9.600 N	Basic static load rating, radial
n _G	3.350 1/min	Limiting speed
≈m	140 g	Weight



Dimensions

r_{\min}	0,6 mm	Minimum chamfer dimension
d_1	169,8 mm	Shoulder diameter inner ring
D_1	173,1 mm	Shoulder diameter on outer ring wide side face
D_2	174,3 mm	Shoulder diameter on outer ring small side face
α	30 °	Contact angle

Temperature range

T_{\min}	-30 °C	Operating temperature min.
T_{\max}	120 °C	Operating temperature max.

Characteristics

-  Radial load
-  Axial load in one direction
-  Grease Lubrication
-  Oil Lubrication
-  Not sealed