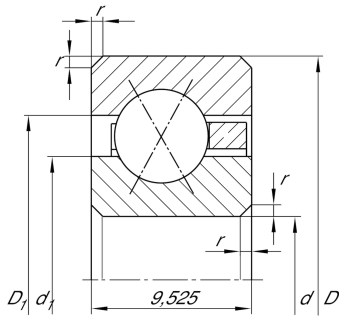

**CSXC045**

Four-point contact bearing

Four point contact bearing, Thin section bearing CSXC, brass sheet metal cage

Technical information

**Your current product variant**

Logistical code	HLE	-
Type of Sealing	Without	Not sealed
Cage	YH	Brass sheet metal
Tolerance class	PL1	Class PL1, Normal
Radial internal clearance	PL1	Class PL1, Normal
Lubricant	Without	Bearing not greased

Main Dimensions & Performance Data

d	114,3 mm	Bore diameter
D	133,35 mm	Outside diameter
B	9,525 mm	Width
C_r	10.800 N	Basic dynamic load rating, radial
C_{0r}	16.100 N	Basic static load rating, radial
n_G	2.750 1/min	Limiting speed
m	220 g	Weight

Dimensions







r_{min}	1 mm	Minimum chamfer dimension
d_1	121,3 mm	Shoulder diameter inner ring
D_1	126,3 mm	Shoulder diameter outer ring
α	30 °	Contact angle



Temperature range

T_{min}	-30 °C	Operating temperature min.
T_{max}	120 °C	Operating temperature max.

Characteristics

-  Radial load
-  Axial load in one direction
-  Axial load in two directions
-  Grease Lubrication
-  Oil Lubrication
-  Not sealed