

**CSXC090**

Four-point contact bearing

Four point contact bearing, Thin section bearing CSXC, brass sheet metal cage

Technical information

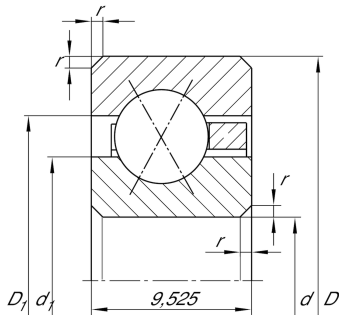

Your current product variant

Logistical code	HLE	-
Cage	YH	Brass sheet metal
Radial internal clearance	PL1	Class PL1, Normal
Lubricant	Without	Bearing not greased

Main Dimensions & Performance Data

d	228,6 mm	Bore diameter
D	247,65 mm	Outside diameter
B	9,525 mm	Width
C _r	13.800 N	Basic dynamic load rating, radial
C _{0r}	31.500 N	Basic static load rating, radial
n _G	1.240 1/min	Limiting speed
≈m	430 g	Weight

Dimensions

r _{min}	1 mm	Minimum chamfer dimension
d ₁	235,6 mm	Shoulder diameter inner ring
D ₁	240,6 mm	Shoulder diameter outer ring
α	30 °	Contact angle



Temperature range

T_{min}	-30 °C	Operating temperature min.
T_{max}	120 °C	Operating temperature max.

Characteristics



Radial load



Axial load in one direction



Axial load in two directions



Grease Lubrication



Oil Lubrication



Not sealed