

**CSXG180**

Four-point contact bearing

Four point contact bearing, Thin section bearing CSXG, brass sheet metal cage

Technical information

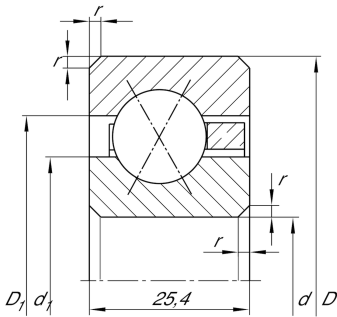

Your current product variant

Logistical code	HLE	-
Cage	YH	Brass sheet metal
Radial internal clearance	PL1	Class PL1, Normal
Lubricant	Without	Bearing not greased

Main Dimensions & Performance Data

d	457,2 mm	Bore diameter
D	508 mm	Outside diameter
B	25,4 mm	Width
C_r	85.000 N	Basic dynamic load rating, radial
C_{0r}	219.000 N	Basic static load rating, radial
n_G	510 1/min	Limiting speed
m	6,21 kg	Weight

Dimensions

r_{min}	2 mm	Minimum chamfer dimension
d_1	476,1 mm	Shoulder diameter inner ring
D_1	489,2 mm	Shoulder diameter outer ring
α	30 °	Contact angle



Temperature range

T_{min}	-30 °C	Operating temperature min.
T_{max}	120 °C	Operating temperature max.

Characteristics



Radial load



Axial load in one direction



Axial load in two directions



Grease Lubrication



Oil Lubrication



Not sealed



Large bearing