

**CSXU040-2RS**

Four-point contact bearing

Four point contact bearing, Thin section bearing CSXU..-2RS, seals, brass sheet metal cage

Technical information

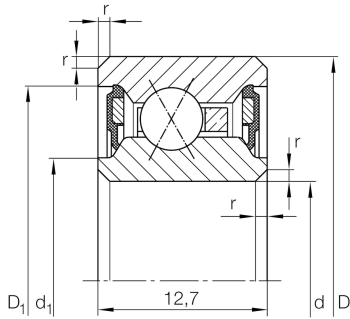

Your current product variant

Logistical code	HLE	-
Type of Sealing	2RS	Contact seal on both sides
Cage	YH	Brass sheet metal
Tolerance class	PL1	Class PL1, Normal
Radial internal clearance	PL1	Class PL1, Normal
Lubricant	Lubricating grease	

Main Dimensions & Performance Data

d	101,6 mm	Bore diameter
D	120,65 mm	Outside diameter
B	12,7 mm	Width
C_r	10.400 N	Basic dynamic load rating, radial
C_{0r}	14.400 N	Basic static load rating, radial
n_G	2.190 1/min	Limiting speed
m	250 g	Weight









Dimensions

r_{min}	0,38 mm	Minimum chamfer dimension
d_1	108,6 mm	Shoulder diameter inner ring
D_1	113,6 mm	Shoulder diameter outer ring
d_1	105,4 mm	Caliber diameter inner ring
D_1	115,5 mm	Caliber diameter outer ring
α	30 °	Contact angle

Temperature range

T_{min}	-25 °C	Operating temperature min.
T_{max}	120 °C	Operating temperature max.

Characteristics

-  F_r Radial load
-  F_a Axial load in one direction
-  F_a Axial load in two directions
-  L_h Lifetime lubrication, freedom from maintenance
-  Grease Lubrication
-  Sealed on both sides