

**CSXU110-2RS** [↗](#)

## Four-point contact bearing

Four point contact bearing, Thin section bearing CSXU..-2RS, seals, brass sheet metal cage

## Technical information

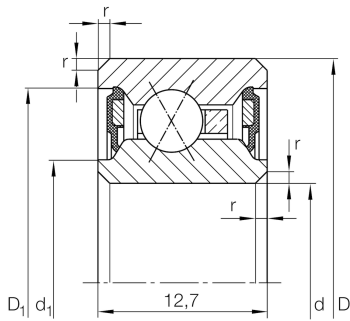

## Your current product variant

Logistical code	HLE	-
Type of Seal	2RS	Contact seal on both sides
Cage	YH	Brass sheet metal
Tolerance class	PL1	Class PL1, Normal
Radial internal clearance	PL1	Class PL1, Normal
Lubricant	Lubricating grease	

## Main Dimensions &amp; Performance Data

d	279,4 mm	Bore diameter
D	298,45 mm	Outside diameter
B	12,7 mm	Width
$C_r$	14.800 N	Basic dynamic load rating, radial
$C_{0r}$	38.500 N	Basic static load rating, radial
$n_G$	690 1/min	Limiting speed
$m$	0,65 kg	Weight









### Dimensions

$r_{min}$	0,38 mm	Minimum chamfer dimension
$d_1$	286,4 mm	Shoulder diameter inner ring
$D_1$	291,4 mm	Shoulder diameter outer ring
$d_1$	283,2 mm	Caliber diameter inner ring
$D_1$	293 mm	Caliber diameter outer ring
$\alpha$	30 °	Contact angle

### Temperature range

$T_{min}$	-25 °C	Operating temperature min.
$T_{max}$	120 °C	Operating temperature max.

### Characteristics

-  Radial load
-  Axial load in one direction
-  Axial load in two directions
-  Lifetime lubrication, freedom from maintenance
-  Grease Lubrication
-  Sealed on both sides