

**FAG****NN3044-AS-K-M-SP**

Cylindrical roller bearing

Super precision cylindrical roller bearings
 NN30...-AS-K-M-SP, non-locating bearing,
 double row, with tapered bore, taper 1:12,
 separable, with cage

Technical information

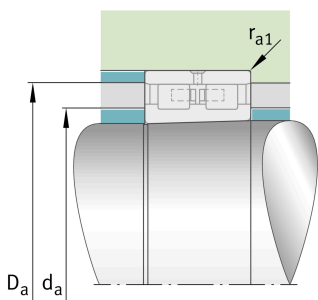
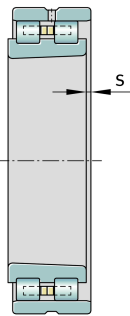
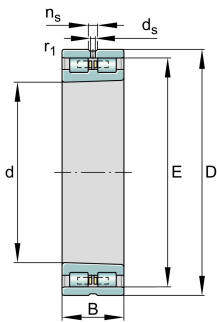

Your current product variant

Cage	M	Brass Cage
Tolerance class	SP	Tolerance class SP
Bore type	K	Tapered, taper 1:12
Change mark	A	Internal Variant A
Radial internal clearance	C1 (Group 1)	Internal clearance smaller than C2
Number of rows	2	Double-row design

Main Dimensions & Performance Data

d	220 mm	Bore diameter
D	340 mm	Outside diameter
B	90 mm	Width
C_r	810.000 N	Basic dynamic load rating, radial
C_{0r}	1.450.000 N	Basic static load rating, radial
C_{ur}	166.000 N	Fatigue load limit, radial
n_G Grease	2.290 1/min	Limiting speed for grease lubrication
n_G Oil	2.700 1/min	Limiting speed for oil lubrication
$\approx m$	29,1 kg	Weight



Mounting dimensions

d_a	254 mm	Diameter shaft shoulder
	h12	Diameter shaft shoulder tolerance
D_a	317 mm	Diameter of housing shoulder
	H12	Shoulder diameter outer ring clearance
$r_{a1 \max}$	2,5 mm	Maximum recess radius





Dimensions

$r_{1 \min}$	3 mm	Minimum chamfer dimension
E	310 mm	Raceway diameter outer ring
n_s	15 mm	Width of lubricating groove
d_s	8 mm	Diameter lubrication hole
s	5,7 mm	Axial displacement

Temperature range

T_{\min}	-30 °C	Operating temperature min.
T_{\max}	150 °C	Operating temperature max.

Characteristics

	Radial load
	Grease Lubrication
	Oil Lubrication
	Not sealed
	Large bearing